

# CCRADIO SOLAR

## INSTRUCTION MANUAL

PLEASE READ ALL THE INSTRUCTIONS  
COMPLETELY BEFORE USE AND SAVE  
THIS MANUAL FOR FUTURE REFERENCE



C.CRANE

## About The CCRadio Solar

---

The CCRadio Solar is likely the first emergency radio that doesn't look like one. The idea simmered at C. Crane for over five years while 10 prototypes were designed. It has an oversized AM antenna for superior long distance reception. FM reception is good thanks to the latest chip technology. The solar panel is oversized to help keep the battery charged.

It is simple to use if you prefer to keep it that way, but there are some hidden features listed underneath the battery compartment cover. The radio is initially delivered set to "low power" consumption to conserve the battery. While the radio is "ON", Press the number "1" and "5" keys simultaneously and the radio will switch to high audio power. The special rubber shell is oil and ultra-violet resistant to yellowing over time.

Please consult the manual on how to charge your phone. Crisis hint: If all power lines and the phone system are down, use texting to send a message with your cell phone. It requires very little power and a text message can often get through to your loved ones when a normal phone call will not connect.

The heart of your radio is a lithium-ion battery which can last up to 10 years if you show it a little exercise and sun. Please fully charge the battery with a USB cable or optional AC Adapter once or twice a year. Please fully discharge the battery (by leaving the flashlight on until it goes off), one time once a year, and then recharge for 12 hours via a USB cable or optional AC Adapter.

## About The CCRadio Solar

---

### NOTES:

- When the battery is low it will affect radio performance.
  - The radio shuts off when a low voltage limit has been reached of approximately 3.4 volts to protect the battery.
  - If the battery drops below 3.4 volts you may need to charge it with an external charger for the battery. We recommend that you search on the Internet for “NITECORE UI1 Single-shot”.
- 

### BATTERY ICON DEFINITION:

<b>0 bar =</b>	<b>1 bar =</b>	<b>2 bars =</b>	<b>3 bars =</b>
less than 3.4 volts	3.4 - 3.7 volts	3.7 – 4.0 volts	4.0 – 4.2 volts

---

**NOTE: (SOLAR PANEL)** It may be of some advantage to capture morning or evening sunlight by positioning the radio on end (with the flashlight facing down) and the panel facing the sun. Alternatively, one could also tilt or prop the radio at a slant to optimize the solar angle.

## Unpacking/Before Use

---

### UNPACKING

The box should contain the CCRadio Solar radio, (1) Auxiliary In cable, (1) USB 2.0 Charging cable, warranty card and user manual. If anything is missing or damaged, please contact your dealer immediately. We recommend that you keep the packaging in the unlikely event your radio may need servicing.

---

#### FOR YOUR FUTURE REFERENCE:

Serial No. (Found inside battery compartment): \_\_\_\_\_

Date of purchase: \_\_\_\_\_

Name & address of dealer: \_\_\_\_\_

---

**WARNING: TO PREVENT FIRE OR ELECTRIC SHOCK HAZARD DO NOT EXPOSE THIS PRODUCT TO RAIN OR MOISTURE.**

**CAUTION**

**RISK OF ELECTRIC SHOCK  
DO NOT OPEN**

**CAUTION: TO REDUCE THE RISK OF ELECTRIC SHOCK, DO NOT REMOVE THE RADIO BACK. NO USER SERVICEABLE PARTS INSIDE. REFER SERVICING TO QUALIFIED SERVICE PERSONNEL.**

## Safety Instructions

---



THE LIGHTNING FLASH AND ARROWHEAD WITHIN THE TRIANGLE IS A WARNING SIGN ALERTING YOU OF “DANGEROUS VOLTAGE” INSIDE THE RADIO.



THE EXCLAMATION POINT WITHIN THE TRIANGLE IS A WARNING SIGN ALERTING YOU OF IMPORTANT INSTRUCTIONS ACCOMPANYING THIS RADIO.

---



### CAUTION

- Before turning the unit on, set your volume control to a low setting.
  - Slowly increase the sound until you can hear it comfortably and clearly without distortion.
  - Long-term exposure to loud sounds may cause hearing damage. It is best to avoid high volume levels when using headphones/earbuds, especially for extended periods.
- 



### PLEASE READ BEFORE USING THE RADIO

- Please fully charge the internal battery before use.
  - We recommend the internal battery to be fully depleted and fully recharged every 6 months if the radio has not been used. This will help maintain optimal battery life.
  - Keep these precautions and instructions where all who will use this radio will read them.
-

## Safety Instructions

---

To prevent damage to your radio or possible injury to you or others, read these safety precautions and instructions entirely before applying power to the radio.

### 1) COMMON CARE

Check the radio and any accessories regularly. Do not use the radio if there is any sign of damage. Only operate in accordance with the instructions in this manual. Only use attachments or accessories specified by C. Crane. **NOTE:** If the radio is unused for more than 6 months, we recommend winding the crank for at least 30 seconds to keep the battery healthy. Thereafter we recommend charging the battery fully before returning to storage.

### 2) DISCONNECT THE RADIO IN CASE OF MALFUNCTION ⚠

We recommend charging with a computer or USB wall adapter with at least 1000Ma power output for best performance. Use only the recommended adapter. Otherwise, it may damage the radio or cause a fire or electric shock.

### 3) KEEP OUT OF REACH OF CHILDREN ⚠

Dropping the radio can cause damage or injury. Keep the AC Adapter cord in a position so someone cannot trip and cause the radio to fall.

### 4) KEEP AWAY FROM WATER AND MOISTURE ⚠

Keep the radio dry. Liquids and moisture can damage the radio. If a liquid leaks into the radio do not operate and seek a qualified service shop.

### 5) KEEP AWAY FROM EXTREME TEMPERATURES

Extreme temperatures can damage the radio. Never put the radio in direct sunlight in an unventilated area or behind glass or the inside of a car. The appliance should be away from heat sources such as radiators, heat registers, stoves, or other appliances that produce heat.

**CAUTION:** Some windows may intensify the sun's effect on your radio, causing melting or a potential fire hazard.

### 6) DO NOT ATTEMPT TO SERVICE RADIO ⚠

Refer all service work to a qualified service shop when the radio does not appear to operate normally, exhibits a change in performance or the radio has received damage. Never open the radio as this may expose you to dangerous voltages and this will void all warranties.

### 7) OUTSIDE ANTENNAS OR CABLES ⚠

Outside antennas or cables that create a potential hazard should not be used with this radio unless installed by qualified personnel.

### 8) BATTERY CARE ⚠

If the radio is left unattended and unused for long periods of time, remove the batteries. The batteries may leak and damage furniture or your radio.

## Table of Contents

---

About The CC Radio Solar _____	02
Unpacking / Before Use _____	04
Safety Instructions _____	05

### Power Options

Using the Solar Panel _____	11
Power by Winding _____	11
Power by AC Charging Adapter _____	11
Batteries _____	12

### Radio Operation

Display Panel _____	14
Powering the Radio/Sleeptimer _____	16
Tuning Up/Down _____	16
Change Bands/Set Weather Alert _____	16
Volume Control _____	17
Saving a Station to Memory _____	17



## Table of Contents

---

Display Light _____	17
Earphone Jack _____	18
Aux Input Jack _____	19
Radio Power/Charging Jack _____	19
Battery Selection Switch _____	19
Flashlight _____	20
Lock Radio _____	20
Phone Charger Jack (USB) _____	21
Setting the Clock _____	22
Setting the Alarm _____	23
Disable Beep _____	24
Designate Frequency or Clock _____	24
Activate 9 or 10kHz Tuning _____	25
Enable High Power Audio Mode _____	25
Activate 1 kHz Tuning _____	26
Activate Narrow Am Filters _____	26

## Table of Contents

---

Reset to Factory Defaults	27
Change Memory Pages	27
<b>Troubleshooting Guide</b>	<b>28</b>
Specifications	33
Optional Accessories	35

## Power Options

---

### POWER USING THE SOLAR PANEL

Place the solar panel in direct sunlight. It is best to angle the solar panel so that it is pointed directly at the sun. Do not charge the radio in a hot area like a car. To charge the internal Li-ion battery with the solar panel, it is best to leave the radio OFF. Eight hours of direct sunlight should provide about 10 to 14 hours of playtime at medium volume, depending on sun intensity. Set the “Battery Selection Switch” to Li-ion to play. (See Page 19).

---

### POWER BY WINDING

Unfold the Dynamo Crank from the back of the radio and rotate in either direction. Proper winding speed is about 2 rotations per second or greater. After 90 seconds of winding the radio will play for about 8-13 minutes. This varies depending on the winding speed, volume level and band selection. **NOTE:** If the Li-ion battery has been fully depleted (less than 3.3 volts) for many days (or depleted by the flashlight) then it may take extra winding before the battery will power the radio again (greater than 3.3 volts).

---

### POWER BY AC CHARGING ADAPTER (OPTIONAL ACCESSORY NOT INCLUDED)

Connect the AC charging adapter to a 120Volt/60Hz wall power outlet and to the Micro-USB charging jack  on the side of the radio beneath the rubber flap. This adapter can remain plugged

## Power Options

---

into the radio for continuous power but there may be added noise or interference while listening to the AM radio band. We recommend listening to the AM radio band with power adapter unplugged for best reception. To fully charge the included Li-ion battery, keep the AC adapter connected for about 10 - 12 hours with the power off.

---

### POWER USING “AA” BATTERIES

When using “AA” Alkaline batteries the radio should play at normal volume for about 40 hours. When using nickel metal hydride (NiMH) rechargeable “AA” batteries, about 35 hours of play can be expected. This radio will not charge “AA” batteries.

**NOTE: Do not use Lithium type “AA” batteries.**

### INSTALLING “AA” OR “18650” BATTERIES

- 1) Position the radio face down on a soft surface to protect it.
- 2) Remove the Battery Cover using your fingernail or a small tool.

*Press and lift the area indicated*

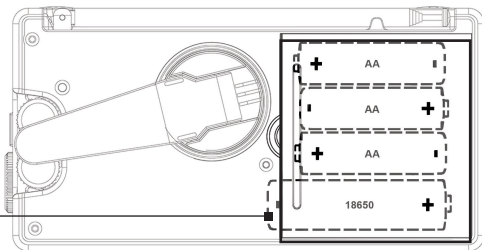

- 3) Insert (3) “AA” cell batteries (optional) or one (1) 18650 Li-ion battery (included) into the compartment as indicated. (Do not use Lithium “AA” size batteries). Be sure the negative (-) end of each battery is against the spring.
- 4) Replace the battery cover. You are now ready to operate your radio.

## Radio Operation

---

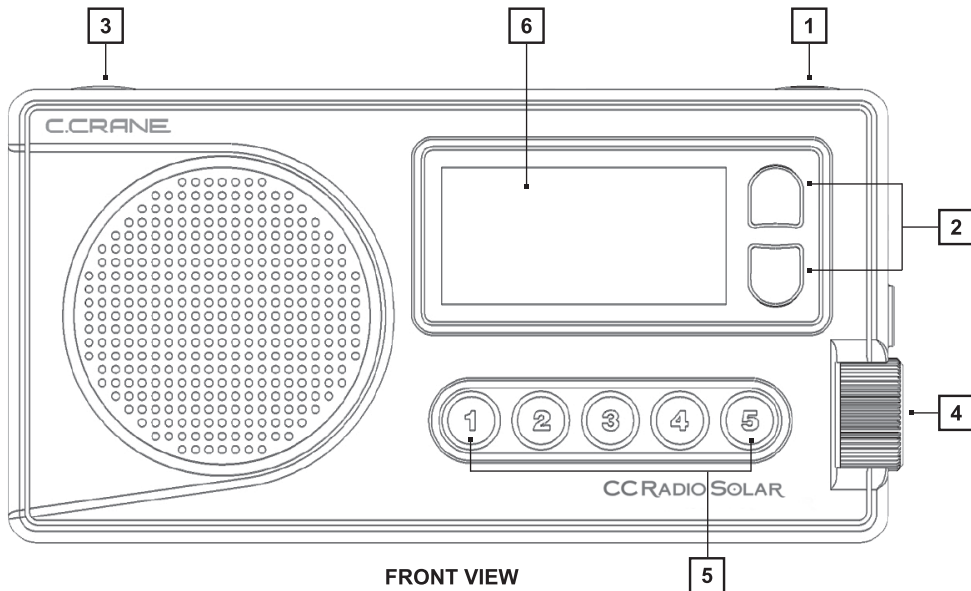

## Radio Operation

### DISPLAY PANEL

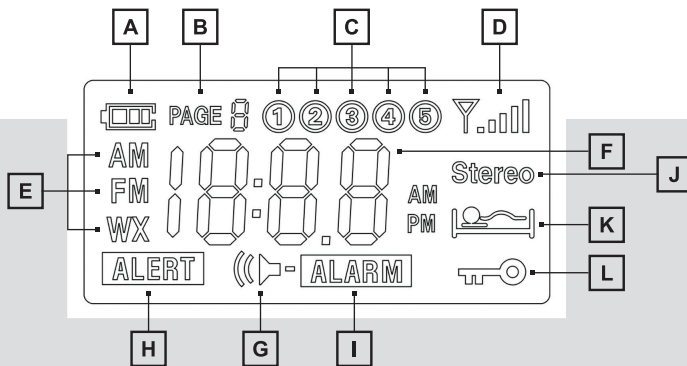

**A)** Battery Icon

**B)** Page Number  
(for station memories)

**C)** Station Memories 1 - 5

**D)** Reception Signal Strength

**E)** Band Indicator

(AM, FM, Weather)

**F)** Frequency/Time

**G)** Beep ON/OFF

**H)** Alert is activated

**I)** Alarm is activated

**J)** Stereo FM reception

**K)** Sleep Timer is activated

**L)** Lock Switch is activated  
(buttons are disabled)

### **1. POWER BUTTON / SLEEP TIMER**

To turn the radio “ON” just press and release the red button. To use the Sleep Timer, press and hold the red button. The Sleep Timer will automatically shut off the radio after the set amount of time expires. The display will cycle through minutes 120, 90, 60, 45, 30, 15, and OFF. Release the power button to activate the sleep setting you desire. The radio will remember your last Sleep Timer setting the next time you activate it.

### **2. TUNING BUTTONS**

Press once quickly to tune to the next frequency increment. Press and hold for 1-second to automatically tune to the next strong station. Hold continuously to cycle through the whole band.

### **3. CHANGE BANDS AND SET WEATHER ALERT**

Press and release the BAND button to cycle between FM, AM, and Weather. The BAND button can also be used to set the weather alert. When the weather alert is activated it will monitor the selected weather channel for NOAA weather alerts. When a NOAA alert is issued (on the selected weather channel) the CCRadio Solar will beep and provide important information. To activate the NOAA Weather Alert, press and hold “Band” button for more than 3 seconds. Continue holding to select how long the alert will be activated for (4hr, 8hr, and 16hr). Release the button to make your selection.



## Radio Operation

---

The display light will flash once every few seconds to remind you that the NOAA Weather Alert is “ON”. To turn the alert “OFF”, hold the Band button for three seconds until “OFF” is displayed and beep is heard, then release the button.

### 4. VOLUME CONTROL

Rotate to adjust volume.

### 5. STATION MEMORY BUTTONS 1 - 5

Save your favorite stations to memory buttons. To save a station, press and hold any memory button for 2 seconds while the station is playing. To play a saved station, press the same button once quickly.

### 6. DISPLAY LIGHT

The LCD Display light will stay enabled for 10 seconds after each button press. If the radio is plugged into continuous power you can keep the display light on continuously while the radio is on. For this, press and hold the POWER and LIGHT button until the display cycles to your desired brightness and then release.  
(See below).

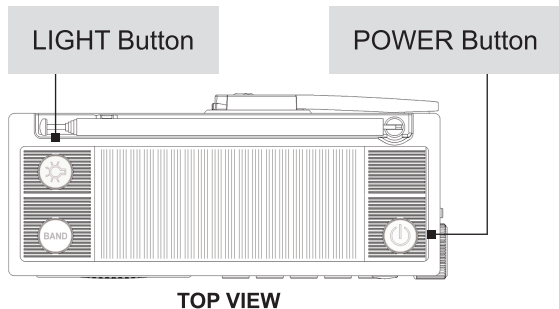

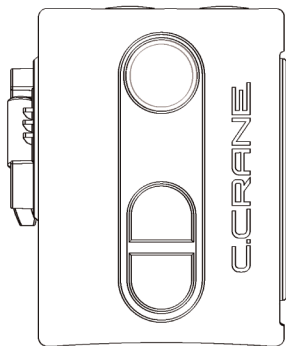

LEFT SIDE VIEW

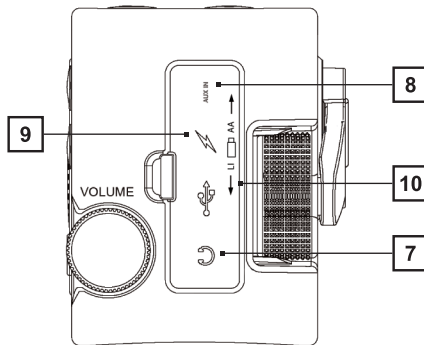

RIGHT SIDE VIEW

### 7. EARPHONE JACK

To listen using earphones, connect your earphones to the lower round jack behind the rubber cover. When earphones are plugged in, stereo sound can be heard from strong FM stations offering stereo sound. Weak FM stations, all AM stations, and Weather stations will be received in mono sound.

### **8. AUX INPUT JACK**

To use the CCRadio Solar as a speaker for your device, connect a 1/8" stereo patch cable (included), with one end of the patch cable to your device's audio output jack (or a headphone jack) and the other end to the Aux input jack (upper round jack under the rubber cover) of the CCRadio Solar. The radio will automatically detect when a device is plugged-in and change to AUX input mode. High power audio mode will always be used with AUX input for best sound quality.

### **9. RADIO POWER/CHARGING JACK**

Connect any Micro-USB cable for continuous power or to charge the radio battery. You will notice some noisy interference while listening to the AM Radio band with power connected.

### **10. BATTERY SELECTION SWITCH**

Please see Page 13 for opening the battery compartment and inserting batteries. The CCRadio Solar uses one 3.7V Lithium-ion 18650 rechargeable battery (included). This battery will give you about 300-500 full charge and discharge cycles and play the radio for about 40-50 hours on low power mode. It is replaceable at [ccrane.com](http://ccrane.com). You might want to charge and keep a second battery for backup power. Optionally three "AA" alkaline batteries can be used to power the radio as an alternative source of power. If using alkaline batteries then you will need to flip the switch "up" under the rubber flap to "AA".

## Radio Operation

---

### 11. FLASHLIGHT

Located on the left side of the CCRadio Solar is a flashlight consisting of one super bright LED. To turn the flashlight on, press the “Light”  button once and release. The “Light” button will glow in the dark to help you locate the radio in a power outage.

**NOTE:** In an emergency we recommend using the flashlight sparingly if your battery is low. The flashlight is quite powerful using about 2 or 3 times the energy of playing the radio.

### 12. LOCK RADIO

Press and hold the BAND and POWER buttons at the same time for two seconds to disable all buttons. Repeat to enable all buttons again. While the buttons are locked the VOLUME knob will continue to work as normal.

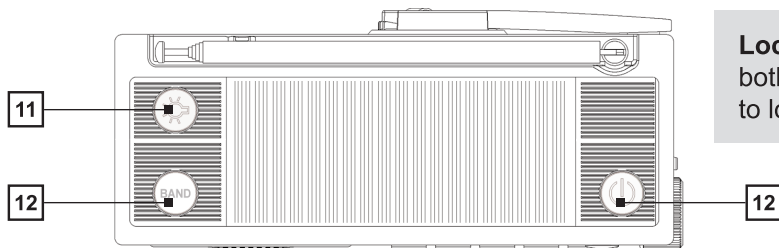

TOP VIEW

**Lock Radio.** Press and hold both buttons for two seconds to lock radio.

## Radio Operation

### 13. PHONE CHARGER JACK (STANDARD USB PORT)

In an emergency, you may need to power your cell phone to make an important call. Cranking the radio for just 90 seconds should give you enough time to make a few quick calls. This, of course, will depend on the make and model of your cell phone. Attach your phone's charging cable (not included) to the full size USB port located under the rubber flap on the right side of the radio. To begin charging, press and hold the "Light" button for 2 seconds. You will notice the battery icon on the screen moving to indicate that charging has begun. Your phone should also indicate that it is charging. If your phone or device will not accept the radio charge, then try fully powering off your device and try again. When the radio battery is fully depleted then charging will stop.

**NOTE:** In an emergency situation where the phone circuits have overloaded or failed, texting may work better for conserving battery life. Text messages will usually send automatically once reception improves for a moment.

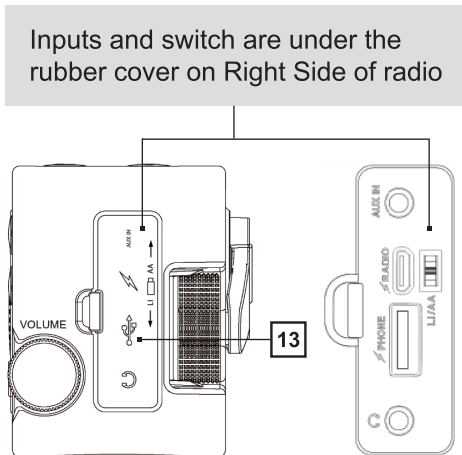

### SETTING THE CLOCK

1. With the power OFF, press and hold memory button #1 for two seconds.  
Release.
2. While the Hour is flashing, press the Up or Down Tuning buttons until the hour and AM/PM time is correct.
3. Press and release memory button #1 to adjust the minutes. Cycle minutes using the Up or Down Tuning buttons.
4. Press and release memory button #1 again after the time is set correctly.

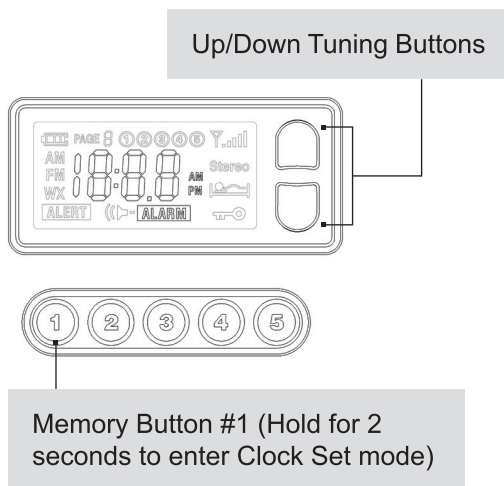

## Radio Operation

### SETTING THE ALARM

1. With the power OFF, press and hold memory button #2 for two seconds. Release.
2. While the Hour is flashing, press the Up or Down Tuning buttons until the hour and AM/PM time is correct.
3. Press and release memory button #2 to adjust the minutes. Cycle minutes using the Up or Down Tuning buttons.
4. Press and release memory button #2 again after the time is set correctly. To disable the alarm, press and hold memory button #2 for two seconds.

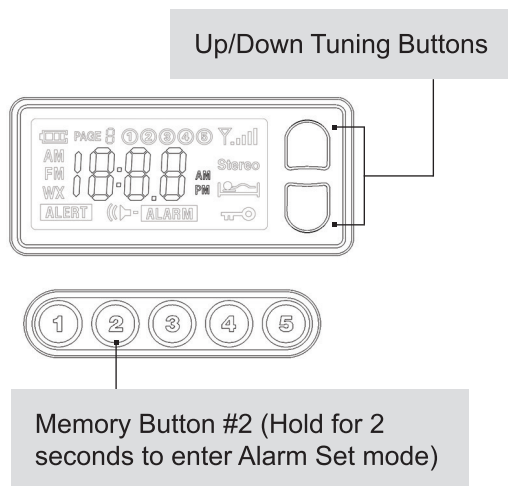

## Radio Operation

---

### DISABLE BEEP SOUND

1. With the power OFF, press and hold memory button #3 for two seconds. All beeps are disabled except ALARM and WX ALERT.
2. Repeat sequence to enable beep again.

Memory Button #3  
(Hold for 2 seconds  
to disable beep)

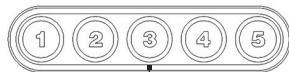

---

### DESIGNATE FREQUENCY OR CLOCK WHILE LISTENING TO THE RADIO

1. With the power OFF, press and hold memory button #4 for two seconds. “C” will appear on the screen indicating that the Clock will show while listening to radio (after 10 seconds).
2. Repeat sequence to display Frequency instead. “F” will appear on the screen to indicate that the Frequency will show when listening to the radio.

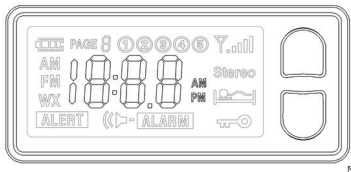

Memory Button #4  
(Hold for 2 seconds)



## Radio Operation

---

### ACTIVATE 9 OR 10 KHZ AM TUNING (ALSO EXPANDS FM BAND)

1. With the power OFF, press and hold memory button #5 for two seconds to activate 9 kHz AM tuning mode. This will also expand the FM band from 76 MHz to 108 MHz.
2. Repeat sequence to switch back to 10 kHz AM tuning and regular FM coverage

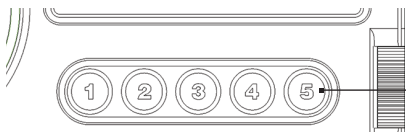

Memory Button #5  
(Hold for 2 seconds to activate 9kHz AM tuning mode. Repeat to switch back to 10kHz)

---

### ENABLE HIGH POWER AUDIO MODE

Quickly press memory buttons #1 and #5 at the same time while listening to your desired station. If a device is connected to the AUX input jack, then high power mode will always be used. **NOTE:** This is used to improve audio quality and loudness but will decrease battery life by about 1/3 or more (depending on volume). We recommend this setting when the radio is connected with the optional AC power adapter.

Memory Buttons #1 and #5  
(Quickly press both buttons to enable High Power mode)



### ACTIVATE 1 KHZ AM TUNING STEPS

Quickly press memory buttons #1 and #4 at the same time while listening to your desired AM station. Press again to return to normal (10 kHz) tuning. **NOTE:** This setting can tune AM stations that are slightly off frequency for various reasons. Tuning 1 kHz higher or lower than the actual station frequency may help improve reception.

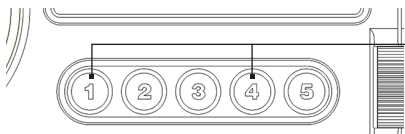

Memory Buttons #1 and #4

(Quickly press both buttons to activate 1 kHz tuning steps.  
Press again to return to normal)

### ACTIVATE NARROW AM FILTERS

Quickly press and release memory buttons #1 and #3 at the same time while listening to your desired AM station. This will change from 2.5kHz (best for voice), 4kHz and 6kHz (best for music) each time buttons are pressed quickly. **NOTE:** This setting is helpful to eliminate unwanted noise or adjacent overlapping stations.

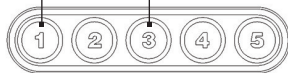

Memory Buttons #1 and #3  
(Quickly press both buttons to  
activate Narrow AM Filters)

## Radio Operation

---

### RESET TO FACTORY DEFAULTS

With power OFF, press and hold memory buttons #1 and #5 for five seconds.



Memory Buttons #1 and #5  
(Press and hold for 2 seconds to reset to factory defaults)

---

### CHANGE MEMORY PAGES (HIDDEN SETTING)

The Page function gives you 20 additional presets for AM and FM. Quickly press memory buttons #3 and #5 simultaneously to enter page selection mode then press memory button 1-5 to select the Page number that you desire. Each page can hold five additional station memories.

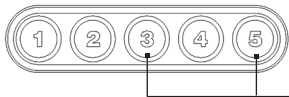

Memory Buttons #3 and #5  
(Quickly press both buttons to enter Page Selection mode.  
Then press 1 - 5 to select page number desired)

### **NONE OF THE BUTTONS WORK, BUT THE DISPLAY SCREEN IS ON:**

The Radio may be locked. If the radio is locked then the LCD display screen will show a key. To release the lock, press and hold the BAND and POWER buttons at the same time for 2 seconds and the key icon will disappear in the LCD Display. (Please see “Lock Radio” on page 20).

---

### **MY RADIO SHUTS OFF AFTER JUST A FEW SECONDS:**

Low batteries can cause this situation. Recharge or replace them with a new set of batteries.

---

### **I HAVE A FULL CHARGE OR NEW BATTERIES IN MY RADIO, BUT THE LCD DISPLAY IS BLANK:**

The battery selector switch under the rubber cover may be in the wrong position or the battery is inserted backwards.

---

### **STATIONS WON'T HOLD IN MEMORY:**

The memory button settings are being overwritten. When recalling a station from memory, if you hold the memory button down too long it will program the current station over your previously stored station. To recall a station that has been stored in memory, always press and release the

---

## Troubleshooting Guide

---

button quickly. To program a new station into memory, tune to the desired station and then press and hold the memory button for two seconds until you hear a beep, or the display shows a memory number.

---

### **THE AM RECEPTION IS POOR:**

You may need to rotate your radio until the reception is best. Many buildings that use brick, metal, or stucco can absorb or reflect the AM signal. Computers, cell phones, tablets, wireless chargers and other electronic equipment, including fluorescent lights, can cause noise that interferes with your AM reception.

Move the radio to a different place to see if that helps. Additional noise may affect a weak signal. Lastly, if your radio is currently charging or connected to a power source then unplug it and try using it on batteries to see if the power source is causing the interference.

---

### **POOR RECEPTION ON FM AND WEATHER BAND:**

The CCRadio Solar can use the silver whip antenna on the top of the radio for FM and Weather bands. To improve reception of these bands, fully extend the whip antenna and try various orientations to obtain the strongest signal.

### **BATTERY POWER LEVEL INDICATOR DOESN'T SHOW FULL CHARGE WHEN USING RECHARGEABLE "AA" NIMH BATTERIES:**

Rechargeable "AA" NiMH batteries will not show a full charge on your radios display. The CCRadio Solar is calibrated to read the charge of your alkaline batteries, which is 1.5 volts at full charge. Rechargeable NiMH type batteries are fully charged at just 1.25 volts, and so your radio will show a partial charge even if the rechargeable batteries have been fully charged. We do not recommend using Lithium "AA" sized batteries in our products.

---

### **I HAVE THE RADIO IN THE SUN BUT THE BATTERY ICON DOES NOT BLINK:**

The icon blinks when charging by using the micro USB input and the crank. It does not blink when charging in the sun.

---

### **WHY IS IT EASY TO CRANK THE RADIO WHEN THE BATTERY IS FULLY CHARGED:**

When the battery starts to get low it will accept more current and it will become harder to crank.

---

### **MY RADIO WILL NOT POWER WHEN USING THE RECHARGEABLE BATTERY SETTING OR WHEN PLUGGED INTO POWER:**

Make sure that you have removed the small plastic pull tab between the battery and the contact.

---

## Troubleshooting Guide

---

Also be sure that your battery is oriented correctly in the battery compartment and that it is charged sufficiently.

---

### **HOW LONG WILL THE CCRADIO SOLAR PLAY ON A FRESH SET OF ALKALINE BATTERIES?**

Approximately 35 hours of play on high power mode. Approximately 50 hours of play on low power mode.

---

### **WHAT TYPE OF LITHIUM BATTERY IS USED IN THE CCRADIO SOLAR?**

The battery included with the CCRadio Solar is a 18650 Rechargeable Battery – Protected 3.7V Li-ion 3400mAh.

---

### **HOW LONG WILL THE CCRADIO SOLAR PLAY ON A FULLY CHARGED LITHIUM BATTERY?**

The CC Solar will run about 35 hours at high volume or about 50 hours on the energy miser setting. When the battery icon drops to two bars then the battery is approximately half full.

---

### **CAN I HAVE THE WEATHER ALERT SET AND LISTEN TO AM OR FM AT THE SAME TIME?**

Yes you can.

---

### **WHEN CHARGING IN THE SUN USING THE SOLAR PANEL, USING THE USB CABLE OR THE OPTIONAL AC ADAPTER, DOES THE SWITCH NEED TO BE SET TO LI?**

No.

---

### **WILL THE BATTERY INDICATOR SHOW FULL BARS WHEN CHARGED IN THE SUN OR HAND CRANKED?**

Yes, once the battery reaches 4 volts. The following charge times are based on the mAh of the Li-On battery and the mAh of the charging systems for each method:

- Charging in full sun can take approximately 42 hours.
  - Charging with cranking can take approximately 10-12 hours. The fastest way to charge is to use the USB cable or the AC Adapter (sold separately). This method can take up to 10 - 12 hours.
- 

### **HOW DO I RESTORE THE RADIO TO FACTORY DEFAULTS?**

With the power OFF, press and hold the memory buttons #1 and #5 for five seconds. You will hear a tone to signify it has been done.



## Specifications

---

### FREQUENCY RANGE

FM Band: 87.5 – 108 MHz (Regular Mode). / FM Band: 76 – 108 MHz (Expanded Mode – See page 24). / AM Band: 520 – 1710 kHz

---

### WEATHER BAND

Channel 1: 162.400 MHz / Channel 2: 162.425 MHz / Channel 3: 162.450 MHz /  
Channel 4: 162.475 MHz / Channel 5: 162.500 MHz / Channel 6: 162.525 MHz  
Channel 7: 162.550 MHz

---

### POWER SOURCE

- 18650 Li-ion 3.7 volt Rechargeable Battery (3000mAh).
  - “AA” size Alkaline Batteries (Do not use Lithium “AA” batteries).
  - Solar Panel – 110mA (in full unobstructed sun light).
  - Dynamo Wind-up Generator: 300-500ma (at about two rotations per second).
  - 5-Volt DC, 1000mA, Micro USB.
- 

### WARRANTY

1-Year Limited Warranty

---

## Specifications

---

### POWER CONSUMPTION

Low Power Mode 40-100mA DC (depending on headphone or speaker usage and volume level).

High Power Mode: 50-200mA DC (depending on headphone or speaker usage and volume level).

---

### AUDIO

Speaker: 2", 4 Ohm, 3 Watts

Stereo headphone jack 1/8" (3.5mm)

Stereo input jack 1/8" (3.5mm)

---

### ANTENNA

FM and Weather Band: Whip Antenna. / AM Band: Internal Ferrite Bar.

---

### DIMENSIONS

6" W x 3" H x 2.5" D.

---

### WEIGHT

Approximately 18.2 ounces with Li-ion Battery installed.

---

## Accessories

---



### **CCR radio Solar 5V AC Adapter**

Item# CCRSP

\$14.99

---



### **FM Reflect-2 Dipole Antenna**

Item# FMR2

\$14.99

---



### **CC Buds-Pro**

Item # CCBUDSPRO

\$19.99

---

## MODEL: CCRadio Solar

THIS DEVICE COMPLIES WITH PART 15 OF THE FCC RULES. OPERATION IS SUBJECT TO THE FOLLOWING TWO CONDITIONS;

- 1) THIS DEVICE MAY NOT CAUSE HARMFUL INTERFERENCE, AND
- 2) THIS DEVICE MUST ACCEPT ANY INTERFERENCE RECEIVED, INCLUDING INTERFERENCE THAT MAY CAUSE UNDESIRED OPERATION.

**NOTICE:** Any changes or modifications not expressly approved by the party responsible for compliance could void the user's authority to operate the equipment.

**C.CRANE**

**172 Main Street**

**Fortuna, CA 95540-1816**

**Phone: 1-800-522-8863 | Web: [ccrane.com](http://ccrane.com)**

Copyright © 2022 by C. Crane. All rights reserved. No part of this booklet may be reproduced, in any form or means whatsoever, without permission in writing from C. Crane. (Ver 1)