

Mondot

Introduction	4
Features	4
Safety and Care Information	4
Safety and Care Information	5
Warnings	6
What's in the Box?	7
Mondo+ Controls	8
Remote Control	9
Installation	10
Connect to a Wireless Network	10
Manually Connecting to a Wireless Network (optional)	11
Manually Connecting to a Wireless Network (optional)	12
Registering Your Radio To Our Web Portal (optional)	12
Home Screen Icons	13
Navigation Basics	14
Chromecast built-in	15
Chromecast built-in	16
Chromecast built-in	17
Audio Services	18
Bluetooth	18
Aux-in	18
Playing Music from a USB Thumb Drive	19
Playing Music from a USB Hard Drive	19
UPnP Media Servers	19
Spotify Connect (Coming Soon)	19
Multi-Room Mode	20
Radio Settings	21
Alarm Clock and Time Options	21
Setting the Alarm Clock	21
Snooze Timer	22
Sleep Timer	23
Advanced Features (in the Radio Settings Menu)	24
Equalization Settings	24
Increase Battery Life	24
Deep Sleep and Battery Usage	24
Master Power Off	25
Network Info	25
Firmware Update	25
Radio Info / Change Radio Name	26
Factory Reset	26
Display Settings	26

Troubleshooting	28
Listening to SiriusXM	29
Now Playing Screen	30
Viewing and Tuning Channels By Category	30
Viewing and Tuning Channel in a List	31
Start Now	31
Presets	32
Listening to MyMix	33
MyMix Now Playing Screen	33
Personalizing a Channel for MyMix	34
Tuning to a MyMix Channel	34
Ending MyMix	35
Editing a MyMix Channel	35
Listening to On Demand	36
On Demand Now Playing Screen	36
Listening to On Demand Shows	36
Adding an On Demand Show to Favorites	37
Listening to Recent Shows/Channels	38
Listening to On Favorites	39
Listening to a Favorite Show	39
Deleting a Favorite Show	39
Advanced Features	40
Start Now, Pause/Play, Rewind, Fast Forward, and Go to Live	40
TuneStart	40
Enter Your SiriusXM Streaming Account Information	41
Product Specifications	42
Detail Streaming Protocol Support	43
Detail Audio Codec Support	44
Environmental Information	47
FCC Statement	48
Important Legal Information	49
End User License Agreement	49
Cloud Server Terms and Conditions	49
Data Processing for Activation and Auditing Purpose	50
Grace Radio Station List	50
Other Third Party Service Providers	50
Sirius Subscription Information	51
Limited Manufacturer's Warranty	51

Features

Thank you for purchasing the Grace Digital Mondo+. Your Mondo+ comes with everything you need to enjoy music in your home.

- Easy network set up wizard to connect to a wired or wireless network
- Large color display to show station and album artwork
- Powerful full room sound with equalizer settings
- Set multiple alarms, sleep, and snooze timers on the integrated clock
- Save up to 10 favorite presets
- Use Wi-Fi 802.11a/b/g/n/ac on 2.4 or 5 ghz networks with WEP and WPA / WPA2 support
- Integrated internet radio services
- Chromecast built-in for audio: listen to 100's of apps
- Bluetooth to stream any audio service not already provided
- Aux in for a wired connection to an audio device
- UPnP media player to play your saved music on your computer
- Multi-room audio via Chromecast built-in or Grace multi-room to stream aux in, UPnP, Bluetooth audio to every room of your house

Safety and Care Information



IMPORTANT! Always read and understand all the instructions to avoid injury to yourself and/or damage to your device. Grace Digital disclaims all responsibility for damage from data loss due to breakdown, repair, or other causes.

- Do not expose to extreme temperatures (above 140°F or below -4°F, or above 60°C or below -20°C).
- Do not expose to moisture. Do not use device near or in water.
- Do not let any foreign matter spill into device.
- Do not store in dusty areas.
- Do not expose to chemicals such as benzene and thinners. Do not use liquid or aerosol cleaners. Clean with a soft damp cloth only.
- Do not expose to direct sunlight for a prolonged period of time, and do not expose to fire, flame, or other heat sources.
- Do not try to disassemble and/or repair device yourself.
- Do not drop your device or subject it to severe impact.
- Do not place heavy objects on device.
- Do not subject device to excessive pressure.
- If the screen is damaged, do not touch the liquid crystal fluid.

Safety and Care Information





IMPORTANT! Always read and understand all the instructions to avoid injury to yourself and/or damage to your device. Grace Digital disclaims all responsibility for damage from data loss due to breakdown, repair, or other causes.

- Do not expose to extreme temperatures (above 140°F or below -4°F, or above 60°C or below -20°C).
- Do not expose to moisture. Do not use device near or in water.
- Do not let any foreign matter spill into device.
- Do not store in dusty areas.
- Do not expose to chemicals such as benzene and thinners. Do not use liquid or aerosol cleaners. Clean with a soft damp cloth only.
- Do not expose to direct sunlight for a prolonged period of time, and do not expose to fire, flame, or other heat sources.
- Do not try to disassemble and/or repair device yourself.
- Do not drop your device or subject it to severe impact.
- Do not place heavy objects on device.
- Do not subject device to excessive pressure.
- If the screen is damaged, do not touch the liquid crystal fluid.

WARNING!!

- Opening the case may result in electric shock.
- Make sure that you insert the plug all the way into the outlet.
- Do not touch the device with wet hands.
- Do not install near any heat sources such as radiators, heat registers, stoves, or other apparatus (including amplifiers) that produce heat.
- Do not defeat the safety purpose of the polarized or grounding type plug. A polarized plug has two blades with one wider than the other. When the provided plug does not fit into your outlet, consult an electrician for replacement of the obsolete outlet.
- Protect the power cord from being walked on or pinched particularly at plugs, convenience receptacles, and the point where they exit from the apparatus.
- This product contains chemicals known to the State of California to cause cancer and birth defects or other reproductive harm.
- This device should be unplugged from the AC outlet during a thunder and lightning storm, and when the device will not be used for an extended period of time.
- Use the power plug to disconnect the device from the power source. To begin using the device again, reconnect it to an AC outlet.
- Connect the device to an easily accessible AC outlet, so that the device can be quickly disconnected, if necessary.

**CAUTION**
RISK OF ELECTRIC SHOCK
DO NOT OPEN

CAUTION: TO REDUCE THE RISK OF ELECTRIC SHOCK, DO NOT REMOVE COVER (OR BACK). NO USER-SERVICEABLE PARTS INSIDE. REFER SERVICING TO QUALIFIED SERVICE PERSONNEL.

 When found on the apparatus, the lightning flash with arrowhead symbol indicates hazards arising from dangerous voltages.

 When found on the apparatus, the exclamation point within an equilateral triangle symbol indicates the user should read all safety statements found in the user's manual.

 When found on the apparatus, the double box symbol indicates double insulation.

WARNING
TO REDUCE THE RISK OF FIRE OR ELECTRIC SHOCK, DO NOT EXPOSE THIS APPARATUS TO RAIN OR MOISTURE.

What's in the Box?

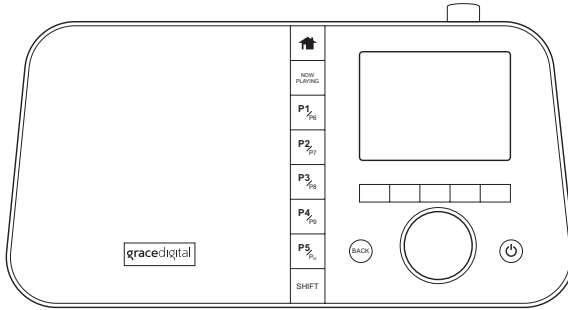

Mondo+

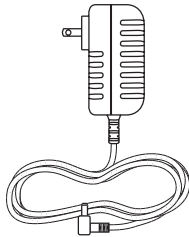

AC Power Adapter

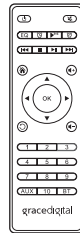

Remote Control



2 Remote Batteries

Mondo+ Controls

Home Button

Press to toggle between the Home Menu / Now Playing Screen.

Action Panel Button/Now Playing

While at the Now Playing screen, press to learn more about the channel, show, or artist, and for additional selection options, for example, customizing a SiriusXM channel (MyMix).

Context Sensitive Buttons

These buttons change their functions according to the context. Press to select the function shown on the display screen just above the button.

BACK Button

Press to return to the previously displayed screen.

P1 - P10 Number Buttons

Press to tune to a favorite station; press and hold to set the current station as a favorite.

Tune Knob (Multifunction)

Turning the knob in a menu or user input screen scrolls through and highlights menus and choices; pressing the knob in a menu or user input screen selects the highlighted item.

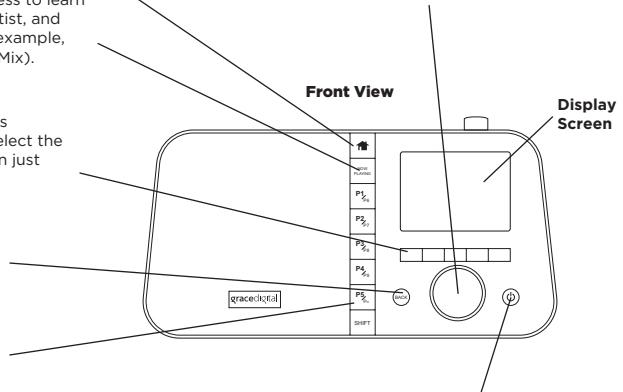

Power/Standby Button

Press to turn On/Standby.

Top View

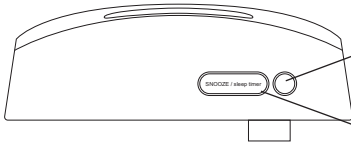

Volume / Mute Knob

Turn to adjust the volume; press down to mute and un-mute audio.

Sleep / Snooze Button

During an alarm press to snooze the alarm for 10 minutes or set snooze time; at the Now Playing screen press to set the sleep timer.

Side View

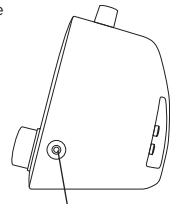

Headphone Connection

Rear View

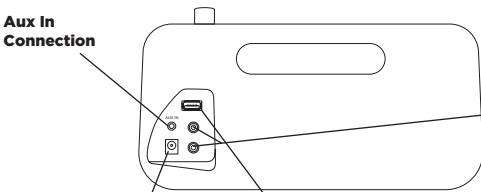

Aux In Connection

Power Connection

USB Connection

For external wired Ethernet Adapter, USB thumb drive, or USB hard drive, sold separately.

RCA Line Out Connection

Remote Control

Power/Standby Button

Press to turn On/Standby.

EQ, Alarm, Sleep, Snooze

Home Button

Press to display the Home screen.

Back Button

Press to return back to the previous display screen.

1-10 Number Buttons

Press to tune to a favorite station; press and hold to set the current station as a favorite.

Battery Replacement

The Remote Control uses two AAA batteries.

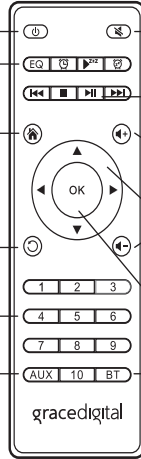

Mute Button

Press to silence the audio.

Play/Pause Button

Press to pause or resume playing. (Limited Support)

Vol+/Vol- Buttons

Press to increase or decrease the audio volume.

Arrow Buttons

Press in a menu or user input screen to scroll through and highlight menu items and choices.

Select Button

Press to select highlighted items.

Aux in Button

Select Aux in as audio source.

Bluetooth Button

Select Bluetooth as audio source.

Connect to a Wireless Network

The easiest way to connect to a wireless network is to have the Mondo+ scan for wireless networks, and then choose your wireless network from the list of wireless networks. The Mondo+ will automatically display the strongest Wi-Fi network at the top of the list.

However, if your wireless network name (SSID) is hidden, or if your network is DHCP disabled, you'll have to manually enter the network settings. Refer to "Manually Connecting to a Wireless Network" on page 11.

Turning the **Tune Knob** scrolls through menus and lists to highlight items, and pressing the **Tune Knob** selects a highlighted item.

Easy Connection to a Wireless Network

1. Plug the AC Power Adapter into an AC outlet, and plug the power plug into the connector on the rear of the Mondo+. Press the **Power Button** if the Mondo+ does not automatically turn on.
2. If the Mondo+ has not previously connected to a wireless network, the Mondo+ will display the Network Wizard screen, with Wireless highlighted. Press the **Tune Knob**.

Otherwise, press the **Home Button**, turn the **Tune Knob** to highlight Setup and press the **Tune Knob** to select. Turn the **Tune Knob** to highlight Network Wizard and press **Tune Knob** to select. Wireless will be highlighted; press **Tune Knob** to select.

3. At the Wireless screen, Scan will be highlighted. Press the **Tune Knob** to select.
4. Wait while the Mondo+ scans for wireless networks and then select your wireless network from the list. Turn the **Tune Knob** to highlight your wireless network and then press the **Tune Knob** to select.
5. The Mondo+ will attempt to connect to the wireless network. If you chose a network that requires a password, you will be prompted to enter the network password. Password will be highlighted. Press the **Tune Knob** to begin entering the password. Otherwise, the Mondo+ will attempt to connect to the wireless network.

6. To enter the network password, turn the **Tune Knob** to highlight each character of the password and press the **Tune Knob** to select the character. Then enter the next character and continue until you have finished entering the password. If you make an error, press the **Delete Button** to erase the character. When you have completed entering the network password, press the **Enter Button**.

7. When the Mondo+ has successfully connected to the wireless network, "Connected successfully" will be displayed.

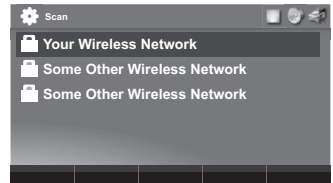
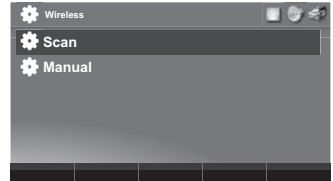

Manually Connecting to a Wireless Network (Optional)

To manually connect to a wireless network, you'll need to know the SSID (wireless network name), password, and type of encryption, and also may need additional information about your wireless network if it is not DHCP enabled:

SSID (wireless network name)	
Password	
Encryption (None, WEP, WPA-PSK)	
IP (Address for the Mondo+)	
Mask (Network Mask IP Address)	
Gateway (Gateway IP Address)	
DNS (Primary Name Server IP Address)	

Plug the AC Power Adapter into an AC outlet, and plug the power plug into the connector on the rear of the Mondo+. Press the **Power Button** if the Mondo+ does not automatically turn on.

- If the Sound System has not previously connected to a wireless network, the Mondo+ will display the Network Wizard screen, with Wireless highlighted. Press the **Tune Knob**.

Otherwise, press the **Home Button**, turn the **Tune Knob** to highlight "Radio Settings" and press the **Tune Knob** to select. Turn the **Tune Knob** to highlight Network Wizard and press **Tune Knob** to select. Wireless will be highlighted; press **Tune Knob** to select.

- At the Wireless screen, Scan will be highlighted. Turn the **Tune Knob** to highlight Manual and then press the **Tune Knob**.



- SSID (wireless network name) will be highlighted. Press the **Tune Knob**. Enter the SSID by turning the **Tune Knob** to highlight each character of the SSID and press the **Tune Knob** to select the character. If you make an error, press the **BACK Button** to erase the character. When you have completed entering the SSID, press the **Enter Button**.
- Turn the **Tune Knob** and highlight Password. To enter the password, turn the **Tune Knob** to highlight each character of the password and press the **Tune Knob** to select the character. If you make an error, press the **BACK Button** to erase the character. When you have completed entering the password, press the **Enter Button**.
- Turn the **Tune Knob** and highlight Encryption. Turn the **Tune Knob** to highlight the type of encryption and press the **Tune Knob** to select.
- If DHCP is enabled on your wireless network, turn the **Tune Knob** and highlight DHCP Connect and press the **Tune Knob**. Skip ahead to step 12.
If DHCP is not enabled on the wireless network, turn the **Tune Knob** and highlight Static IP and press the **Tune Knob**.
- IP will be highlighted. Press the **Tune Knob** to select. Enter the IP Address. The IP address must be entered in the xxx.xxx.xxx.xxx format. When you have completed entering the IP address, press the **Enter Button**.
- Enter the Network Mask in the same way as you entered the IP Address.

16. Enter the Gateway IP Address in the same way.
17. Enter the DNS IP Address in the same way.
18. When all the information has been entered, turn the **Tune Knob** to highlight Connect and press the **Tune Knob**.
19. The Mondo+ will attempt to connect to the wireless network, and will display "Connected successfully" if the connection to the wireless network was successful. If the Mondo+ cannot connect to the wireless network, there is likely an error in the information that was entered.

Registering Your Radio To Our Web Portal (Optional)

The radio works perfectly without registering your radio. However, registering your radio allows a few extra features. It allows you to search our internet radio station database online as well as the audioscar.ch podcast database via your computer's web browser and save your favorite internet radio station and podcast show instantly to your internet radio (this is much easier than searching on the radio itself!). Additionally, our Web Portal allows you to add your favorite radio station or podcast directly to your radio if we don't already have it in our database.

1. Go to www.myradiosplus.gracedigital.com and click **Registration** to create an account.
2. In the menu on the left hand of the browser select **Radios**.
3. In the upper left hand corner select **Add New**.
4. Enter your radio's internal serial number.

NOTE: The serial number required to register your radio is not the serial number on the bottom of the radio. To find your internal serial number please go to your radio's home menu and select **Radio Settings** then select **Radio Info**. On the radio info screen you will see '---serial number---'. The serial number will start with 'gdi'. Please enter the entire serial number into the web portal including 'gdi' in the serial area then select **Save**.

Now you can directly save stations on the web site and add stations and podcast directly into the **My Stuff** folder on your radio.

The **My Stuff** folder can be found after you click on the Internet radio station icon on your home screen.

To save a Station: On the left hand side of the web portal select **Favorites**, then select **Search and Save a Station**. Then enter in the call sign for the station you want to search for (or just search for a genre or station by location) and when you find a station you want to save to your radio select **Add to Favorites** on the right hand side of the resulting station listing(s).

To save a Podcast: On the left hand side of the web portal select **Favorites**, then select **Search and Save a Podcast**. Then enter in the podcast name for the podcast you want to search for (or just search for it by the network name or Category) and when you find the podcast you want to save to your radio select **Add to Favorites** on the right hand side of the resulting station listing(s).

To add a favorite Podcast or stream that we don't have in our databases, select **Add a Podcast** or **Add a Stream** in the **Favorites** menu on the web portal and add the source audio URL. If you do not know the source URL (not just the station URL but the actually URL used to stream music) please contact the podcast or station owner directly.

Home Screen

The Home screen provides access to the different functions of the Mondo+. You can navigate the Home screen by pressing **Home**, turning the **Tune Knob** to highlight an item, and pressing the **Tune Knob** to select.

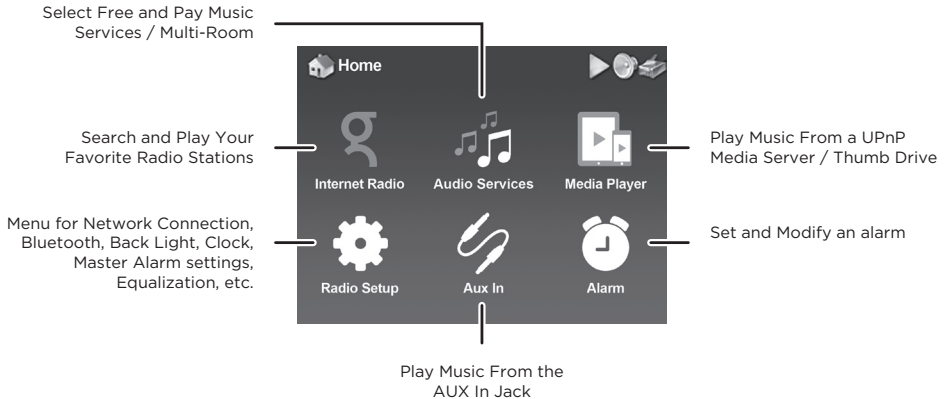

Power Button

The **Power Button** turns the Mondo+ on or places it in Standby Mode. Also press to turn an alarm off.



SNOOZE / Sleep Timer Button

Sleep: When the radio is playing, pressing the **SNOOZE / Sleep Timer Button** then select hours + press the **Tune Knob** then select minutes and press in **Tune Knob**.

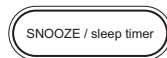

Snooze: Pressing the **SNOOZE / Sleep Timer Button** when a alarm is sounding will set a snooze time of 10 minutes, or you can select the amount of snooze time. To cancel the snooze timer (or cancel an alarm) press the **Power Button**.

To adjust the Sleep or Snooze time to a time other than 10 minutes, press the **SNOOZE / Sleep Timer Button** and turn the **Tune Knob** to adjust the amount of sleep time, hours first, and then press the **Tune Knob** to select the hour setting. Do the same for the minutes.

Context Sensitive Buttons (5)

These buttons change their functions according to the context. Press to select the function shown on the display screen just above the button.

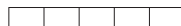

These buttons are described in this User Guide in the context where they appear.

Tune Knob

The **Tune Knob** is multifunction: you can turn it clockwise or counter-clockwise and press it.



Turn: Turning the **Tune Knob** at the Now Playing screen displays the Channel Listing screen. When in menus or user input screens, turning the **Tune Knob** scrolls through and highlights menu items and choices.

Volume Knob

Turning the **Volume Knob** clockwise or counter-clockwise increases or decreases the volume of the audio. Pressing the **Volume Knob** mutes and un-mutes the audio.



Presets P1 - P10

The **Presets** are used to store favorite channels in the button location by pressing and holding the button. Then you can tune a favorite channel just by pressing the button. Pressing **SHIFT** allows you to program 6-10 presets.



The radio currently can only save presets of content found directly on the Mondo+. It cannot save Bluetooth®, UPnP, Aux In, Chromecast as favorites.

BACK Button

The **BACK** Button returns back to the previously displayed screen or Home Screen.



Home Button

Pressing the **Home Button** displays the Home screen showing the listening modes and configuration options for the Sound System.



Now Playing Button

Press to display the Now Playing Screen. Press and hold when using the SiriusXM app for advanced features.



Using Chromecast built-in is as simple as pressing a button from your favorite app. Listen to your top tunes while taking a phone call or sending a text, all without interrupting what's playing on the Mondo+. With Chromecast built-in, your phone is your personalized remote control that you can use to browse, play, pause, and even make playlists. And you don't have to learn anything new! You can stream from Android tablets and smartphones, iPhones, iPads, Mac, Windows, and Chromebooks to the Mondo+.

Before You Begin Streaming to the Mondo+

In order to stream to the Mondo+, it must be on the same local network as the device (smartphone, tablet, laptop, PC etc.) that you will stream from. Please see the previous installation section in this manual on how to connect to a wireless network. Once your Mondo+ is connected to the network there is no additional set up required on the Mondo+ to enable Chromecast built-in.

In order to insure the best experience, please make sure you are running the latest version of the Chromecast-enabled app on your smartphone / tablet etc. You can always double check that you are on the latest version by visiting the Google Play Store or Apple App Store and checking for any app updates.

Stream from Chromecast-Enabled Apps to Your Audio Device

To stream from your mobile device or tablet to the Mondo+:

1. Open a Chromecast-enabled app.
2. In the top right or bottom right corner, tap the Cast button .
3. Choose the Mondo+. The Cast button will become filled, letting you know you're connected.
4. Once you are connected, you can stream music, radio stations, and podcasts directly to the Mondo+.

Multi-Room Playback: How to Create an Audio Group

Multi-room playback allows you to stream the same music to several speakers at the same time. You can use this feature to enjoy your music all around your home. Once you've created your group, your favorite music and audio from Chromecast-enabled apps are instantly available to stream.

Create an Audio Group:

1. From your iPhone or Android device, open the Google Home app.
2. In the upper right corner of the home screen, tap Devices  to see your available Chromecast Audio or speaker with Chromecast built-in. In this area you will see the Mondo+.

NOTE: you can also change the name of the Mondo+ in the Mondo+ settings menu. This will allow you to change the name to Kitchen, Den, Bedroom, or any name you want.

3. In the top right corner of the Mondo+, that you would like to set up in a group, tap the device card menu  > **Create Group**.

4. The default name of the group is "Home group". To rename the group, erase the name and type in something new.
5. You will now see the Mondo+, a list of all available speakers, including Google Home, if available.
6. To add or remove a Mondo+ from the group, tap the box next to its name. A check will appear in the box next to the speaker's name to indicate whether it will be associated with the group.

NOTE: At least two devices must be selected to create a group.

7. Tap **Save**.

8. After the Mondo+ has been successfully added to the group, you will see the group device card within Devices .



NOTE: It may take up to 5-10 seconds for the group device card to appear in the Google Home app. Tap **Speakers in Group** to see which speakers are associated with the group.

NOTE: Multi-room group creation functionality is only available on iOS and Android. This feature is not supported from the Chrome browser. However, you can still stream to a group from Chrome.

For additional tips and troubleshooting please view the Google Home app or Google support at <https://support.google.com/chromecastbuiltin>

Play Audio on the Mondo+ from Google Home

Initiate and control audio to the Mondo+ with Chromecast built-in — using only your voice. Please follow the previous steps in the previous Chromecast section of the menu.

1. Set up your Google Home if it's not set up yet.
2. Open the Google Home app.
3. In the top left corner of the Home screen, tap Menu .
4. Verify that the Google Account that is listed is the one you used to set up Google Home. To switch accounts, click the triangle to the right of the account name.
5. Make sure your Mondo+ is set up and on the same Wi-Fi network as Google Home.
6. Tap **More settings > TVs and Speakers >** . You'll see a list of all your linked devices.
7. To link a new Mondo+, tap the plus sign in the bottom right corner of the screen.
8. The Google Home app will search for voice supports speakers on the same Wi-Fi network as your Google Home.

NOTE: You may see a list of devices that aren't voice-supported. These can't currently be linked to your Google Home, but they'll be available soon.

9. To add a device, tap the checkbox to the right of the device name. You can check multiple devices. Tap **Add**.

10. You will now see all your devices within the TVs and speakers section of the Google Home app.

NOTE: If you receive an "Error when linking device" error message, you must Factory Data Reset (FDR) your Chromecast Audio device.

To unlink a device:

1. In the top right corner of the Home screen, tap Devices .
2. Scroll to the bottom and tap **Linked Devices**.
3. Tap the 'X' next to the device you want to unlink.

Play Audio on the Mondo+ from Google Home

To do this...	Say "Ok Google" then say...
Request a song	<ul style="list-style-type: none"> • Play <song name> on <device name> • Play <song name> by <artist name> on <device name> • Play <song name> on <music service> on <device name>
Request an artist	<ul style="list-style-type: none"> • Play <artist name> on <device name> • Play <artist name> on <music service> on <device name>
Request an album	<ul style="list-style-type: none"> • Play <album name> on <device name> • Play <album name> by <artist name> on <device name> • Play <album name> by <artist name> on <music service> on <device name>
Play music based on genre/mood/activity	<ul style="list-style-type: none"> • Play classical music on <device name> • Play happy music on <device name> • Play music for cooking on <device name> • Play <genre> on <music service> on <device name>
Play personalized suggested content from chosen service	<ul style="list-style-type: none"> • Play some music on <device name> • Play <genre> music on <music service> on <device name>
Play music on your speakers, TV, or video device. NOTE: Device linking is required.	<ul style="list-style-type: none"> • Play music on my living room TV • Play <genre> on my bedroom speakers
Pause	<ul style="list-style-type: none"> • Pause • Pause the music
Resume	<ul style="list-style-type: none"> • Resume • Continue playing
Stop	<ul style="list-style-type: none"> • Stop • Stop the music
Play next song	<ul style="list-style-type: none"> • Next • Skip • Next song
What's playing	<ul style="list-style-type: none"> • What's playing? • What song is playing? • What artist is playing?
Control Volume	<ul style="list-style-type: none"> • Set volume to 5 • Set volume to 40%

In addition to being able to play music via Chromecast enabled apps, you can also play music via Bluetooth, USB drives, UPnP media players, the aux in jack, as well as the music services directly on the radio.

To play a music service on the radio, you can select the appropriate music service or Grace Digital radio service by using the front panel controls, the infra-red remote control, or the free android or iPhone apps.

The music services currently available on the radio are: CBS radio (radio.com), BBC, NPR, iHeartRadio (basic stations only, for advanced features please use the Chromecast enabled app), SiriusXM (A SiriusXM Streaming Subscription is required and sold separately by SiriusXM. See SiriusXM Customer Agreement at siriusxm.com for details.), SHOUTcast, Calm Radio, Live 365, Sleep Sounds, and Podcasts via itunes Podcast database.

Bluetooth

The Mondo+ can work as a Bluetooth speaker. When you power the Mondo+ on for the first time the Mondo+ will automatically be available to connect. If it is not showing up on your smartphone, go into the Mondo+ main 'radio settings' menu, select Bluetooth. If the menu item **Bluetooth Pairing Mode** is displayed on the radio, then you should see it on your smart device. Once you select the Mondo+ in your smart device the radio will now show the name of the smartphone / tablet that it is paired too.

Now on your smart device simply press play on the music that you want to stream via Bluetooth and the music will start playing on the Mondo+. After your initial set up, the next time you want to play Bluetooth you will have to select the device from the Mondo+ menu.

For example, if you are playing Bluetooth music from your smartphone and you then later press the preset 1 on the Mondo+ to play your previously saved radio station. To play Bluetooth music again you will have to select your device from the Mondo+ Bluetooth menu. After you select your device you will be shown 3 options:

Play: If you want to play the music.

Disconnect: If you want to stop playing music but keep the smartphone device in the Mondo+ memory. By doing this, it will release your smartphone from playing music but if you later press play on the Mondo+, assuming your device is still in range, pressing play on the Mondo+ will start playing music from your device again.

Unpair: Will disconnect the Mondo+ and place the Mondo+ into pairing mode to be paired to another phone.

NOTE: If you unpair your smart device and then want to pair back to the Mondo+ again, depending on the smart device you may have to delete the Mondo+ name out of your device's Bluetooth list, or turn Bluetooth on and off on your smart device. Then the Mondo+ will display again and you can repair, connect, and start playing.

Aux In

You can listen to another device such as an MP3 player or Smartphone by plugging it into the Aux In connection on the Mondo+.

To listen using Aux In:

1. Connect a device to the Aux In connection on the Mondo+.
2. Press **Home** and turn the **Tune Knob** to highlight **Aux In**. Press the **Tune Knob** to select.

To exit Aux In:

1. Press the Exit Aux In Button.

Playing Music from a USB Thumb Drive

Insert your USB thumb drive into the Mondo+ and on the radio menu select **Media Player** then select **USB**.

NOTE: USB sticks must be formatted in one of the following protocols: FAT, FAT32, NTFS, ext2, ext3 or ext4.

Playing Music from a USB Hard Drive

Connect your USB hard drive to the Mondo+. If your drive requires more power, you may want to use a USB powered hub in between the Mondo+ and the USB hard drive, then select 'Media Player,' then select 'USB,' then you will be able to navigate and play your music using the **Tune Knob**.

UPnP Media Servers

The Mondo+ will play music from network connected UPnP or DLNA media servers. You must first make sure that the media server is on the same network as the Mondo+, then select 'Media Player,' then select 'UPnP,' then select your device and you will be able to navigate and play your music using the **Tune Knob**.

NOTE: The Mondo+ is a media player and renderer. This means that the features and functionality are driven by your media player software. To optimize the performance, keep your media player folder size to a manageable size. The larger the folder size, the longer it takes the Mondo+ to display the folder content and scroll through them.

Additionally, check the product specifications section of the manual to see the supported protocols pages 43-46. If you have a mixture of supported and unsupported formats in a folder on your media server, depending on your software, the radio will be able to see all, some, or none of the folders. So, it is always best to make sure the folder you want the Mondo+ to access only has supported formats /bit rates etc.

Spotify Connect (Coming Soon)

The Grace Mondo has Spotify Connect built in. Spotify Connect lets you control the music playing on the Mondo+. Using the Spotify app on your mobile, tablet or PC. Learn more at [Spotify.com/connect](https://spotify.com/connect)

How to use Spotify Connect:

You'll need Spotify Premium to use Connect. Learn more at [Spotify.com/premium](https://spotify.com/premium). Follow the steps below:

1. Add your speakers to your Wi-Fi network (see page 10).
2. Fire up the Spotify app on your phone, tablet or PC using the same Wi-Fi network as the Mondo+.
3. Play a song on Spotify and hit 'DEVICES AVAILABLE'.
4. Choose your speakers and your music will start playing out loud on the Mondo+.

Happy listening.

Licenses: The Spotify Software is subject to third party licenses found here: <https://developer.spotify.com/esdk-third-party-licenses/>

To play the same Chromecast built-in audio to multiple Mondo+'s please see the Chromecast built-in section.

To play the same audio (other than Chromecast built-in audio) on multiple Mondo+'s in your home or office you can create groups using the free Grace Controller apps for Android or iPhone. Please download the Grace controller apps at Google Play or the Apple app store and follow the instructions on the respective apps.

The Grace Controller app will allow you to stream any audio source including Bluetooth, aux in, Media Players, USB media (except Chromecast built-in audio) simultaneously to groups of Mondo+'s.

Additionally, on the radio, via the music services folder, you can select any other Mondo+ on your network and the Mondo+ will start playing the same audio that is currently playing on the selected radio (except Chromecast built-in audio).

For example: If you have your Mondo+ in your bedroom playing K-rock, and you want to play the same music on your Mondo+ in your kitchen, on your Kitchen Mondo+ select the music services icon and scroll to the bottom of the menu and select multi-room. In that menu you will see the list of other Mondo+ in your home. Select your bedroom radio and now both your bedroom radio and your kitchen radio will be playing K-rock synchronized.

To simplify your whole home experience you can change the name of your Mondo+ to any name you want such as kitchen, bedroom, den etc. To change the name of your Mondo+ go into the radio settings menu and select 'radio Info, then highlight and select device name. Change the name to what you want then select enter to save the new name. This new name will also display as the name for Bluetooth, Wi-Fi and Chromecast built-in connections.

Alarm Clock and Time Options

Clock set-up option has several selections:

24-hour time: This option sets the time format to a 12 or 24 hour format.

Alarm Clock: The Mondo+ has five alarm clocks, each of which can be configured differently. Refer to “Setting Alarm Clock” for information about the alarm clock.

Timezone: This option sets the Mondo+ to the timezone for your area.

Alarm Fade in: You can set the alarm to have no fade in or set it from 10 seconds to 60 seconds. Enabling fade in provides a gradual increase in alarm volume.

Default Snooze Time: Set the default snooze time for 1 press of the **SNOOZE / Sleep Timer Button**. Turn the **Tune Knob** to configure the amount of time, hours first and then minutes. Turn the **Tune Knob** to select the time and press the **Tune Knob** to confirm.

Default Sleep Time: Set the default sleep time for 1 press of the **SNOOZE / Sleep Timer Button**. Turn the **Tune Knob** to configure the amount of time, hours first and then minutes. Turn the **Tune Knob** to select the time and press the **Tune Knob** to confirm.

To enable or disable 24-hour time:

1. Press the **Home Button** and turn the **Tune Knob** to highlight Radio Settings. Press the **Tune Knob** to select.
2. Turn the **Tune Knob** to highlight Clock and Alarms and press the **Tune Knob** to select.
3. Turn the **Tune Knob** and highlight 24-hour time.
4. Press the **Tune Knob** to enable 24-hour time (when the box has a checkmark in it), or disable (when the box does not have a checkmark in it).

To select the Timezone:

1. Press the **Home Button** and turn the **Tune Knob** to highlight Radio Settings. Press the **Tune Knob** to select.
2. Turn the **Tune Knob** to highlight Clock and Alarms and press the **Tune Knob** to select.
3. Turn the **Tune Knob** to highlight a timezone and press the **Tune Knob** to select. A checkmark in the box next to the timezone indicates the selected timezone.

Setting the Alarm Clock

The Mondo+ has five alarm clocks, each of which can be configured independently.

To Add or Modify an alarm:

1. Highlight **Alarm** on the Home Screen and press the **Tune Knob**.
2. To add an alarm, press the **Add Alarm Button**, or to modify an alarm, turn the **Tune Knob** to highlight an alarm and press the **Modify Alarm Button**.

- Each alarm has configuration options which are summarized in the following table. Turn the **Tune Knob** to highlight a configuration option and press it to select. Then turn the **Tune Knob** to change a setting and press it to confirm the setting.

Alarm Time	12:00 AM - 11:59 PM	Turn the Tune Knob to adjust the hour setting and press the Tune Knob to select. Turn the Tune Knob to adjust the minutes setting and press the Tune Knob to select.
Repeat	One Time, Everyday, Weekly, Weekdays, Weekends, Sunday, Monday, Tuesday, Wednesday, Thursday, Friday, or Saturday	Turn the Tune Knob to highlight the frequency of the alarm and press the Tune Knob to select.
Alarm Channel	Nine buzzer options or select 1 of your 10 presets	Turn the Tune Knob to highlight what you want to wake up to, and press the Tune Knob to select.
Volume	Variable	Turn the Tune Knob to adjust the volume of the alarm and press the Tune Knob to select.

- When you finish configuring the alarm, turn the **Tune Knob** to highlight Save changes and press the **Tune Knob**. An advisory message will be displayed confirming the action selected. When the radio is in standby and you want to modify an alarm without turning it on, briefly pressing the **Home Button** to access the Alarm menu.

To Enable, Disable, or Remove alarms:

- On the Home Screen select Radio Settings and press the **Tune Knob**. Turn the **Tune Knob** to highlight Clock and Alarms and press the **Tune Knob**. Turn the **Tune Knob** to highlight Alarms and press the **Tune Knob**.
- Turn the **Tune Knob** to highlight an alarm from the list and press the **Enable Alarm, Disable Alarm, or Remove Alarm Button**. An advisory message will be displayed confirming the action selected.

To Cancel an alarm:

An upcoming alarm can be cancelled so that it does not sound. If the cancelled alarm has been configured as a repeating alarm, it will be reset to sound at the following scheduled time.

- Press and hold the **Home Button** when in Standby Mode for 2 seconds.

The alarm icon will be removed from the display screen temporarily until after the scheduled time of the alarm has passed. This function **only** cancels the upcoming alarm, it does not disable an alarm series.

Snooze Timer

When the alarm sounds, pressing the **SNOOZE / Sleep Timer Button** will silence the alarm for 10 minutes, or you can select a custom amount of time. After the snooze time elapses, the alarm will sound again.

To Snooze:

1. When the alarm clock is sounding, press the **SNOOZE / Sleep Timer Button** on the top of the Mondo+ once to select the default snooze time of 10 minutes. To select a longer snooze time, press the **SNOOZE / Sleep Timer Button** again to increase the time by 10 minutes. Each time the button is pressed the snooze time is increased by an additional 10 minutes.
2. Alternately you can also select a custom amount of snooze time. Press the **SNOOZE / Sleep Timer Button** and turn the **Tune Knob** to configure the amount of time, hours first and then minutes. Turn the **Tune Knob** to select the time and press the **Tune Knob** to confirm.
3. To change the default Snooze time of 10 minutes, press the **Home Button** and turn the **Tune Knob** to highlight **Radio Settings** and press the **Tune Knob**. Next highlight and press **Alarm Clock and Time Options** and then highlight and press **Default Snooze Time**. Turn the **Tune Knob** to configure the new default time, hours first and then minutes. Turn the **Tune Knob** to select the time and press the **Tune Knob** to confirm.

To cancel a current Snooze:

1. To cancel a current snooze (if you want to get out of bed and the snooze timer is counting down) press and hold the **Home Button** for 2 seconds (this only works during a snooze cycle while the radio is off/ in standby).

Sleep Timer

The sleep timer automatically turns the Mondo+ off after a period of time as you fall asleep. The period of time can be set up to 24 hours.

To turn the Sleep Timer On:

1. When the Mondo+ is on, press the **SNOOZE / Sleep Timer Button** on the top of the Mondo+ once to select the default sleep time of 10 minutes. To select a longer time, press the **SNOOZE / Sleep Timer Button** again to increase the time by 10 minutes. Each time the button is pressed the sleep time is increased by an additional 10 minutes.
2. Alternately you can also select a custom amount of sleep time. Press the **SNOOZE / Sleep Timer Button** and turn the **Tune Knob** to configure the amount of time, hours first and then minutes. Turn the **Tune Knob** to select the time and press the **Tune Knob** to confirm.
3. To change the default Sleep time of 10 minutes, press the **Home Button** and turn the **Tune Knob** to highlight **Radio Settings** and press the **Tune Knob**. Next highlight and press **Alarm Clock and Time Options** and then highlight and press **Default Sleep Time**. Turn the **Tune Knob** to configure the new default time, hours first and then minutes. Turn the **Tune Knob** to select the time and press the **Tune Knob** to confirm.

To cancel the Sleep Timer:

1. To cancel the sleep timer, press the **SNOOZE / Sleep Timer Button**, or press the **Power Button**. The advisory message **Sleep timer deactivated** will be displayed.

Equalization Settings

You can adjust the equalization of the Mondo+ (EQ) to adjust for room acoustics and your listening preferences. You can adjust bass and treble, or you can select a profile such as Rock, Jazz, etc.

To change Equalization:

If you want to change the treble or bass, do the following:

1. Press **Home**, then select **Radio Settings**, then turn the **Tune Knob** to highlight **Equalization**. Press the **Tune Knob** to select.
2. Turn the **Tune Knob** to highlight either **Treble** or **Bass** and press the **Tune Knob** to select.
3. Turn the **Tune Knob** to adjust the equalization and press the **Tune Knob** to select the setting.

If you want to select an equalization profile, do the following:

1. Press **Home**, then select **Radio Settings**, then turn the **Tune Knob** to highlight **Equalization**. Press the **Tune Knob** to select.
2. Turn the **Tune Knob** to highlight **Profile** and press the **Tune Knob** to select.
3. Turn the **Tune Knob** to highlight a profile and press the **Tune Knob** to select the profile.

NOTE: When you select a preset equalization profile and you change the bass and treble the changes will modify the profile that you select (not override them). This allows for a truly custom and personalized sound signature. The factory default settings are the Flat equalization profile with both the bass and treble set at 0.

(Personally, my favorite settings are the Jazz equalization profile with bass set at +1. ☺)

Increase Battery Life

Press the **Power Button** to turn on the Mondo+ and put it into Standby Mode. When in Standby Mode, the radio's infra-red and Wi-Fi transceivers are still operable. This allows the radio to be automatically turned on by the remote or Chromecast built-in stream.

When using a Mondo+ with a battery and not plugging it back into AC power when in standby, go into the Radio Settings menu and Select **Increase Battery Life**. This will turn Wi-Fi off when the radio is in Standby Mode. The radio will not respond to the remote control or remote control app and will manually reconnect to your Wi-Fi when turned back on.

Deep Sleep Mode and Battery Usage

To place the radio into Deep Sleep mode, press the radio's or remote's **Power Button** for 3-4 seconds. To get out of Deep Sleep mode press the **Power Button** for 1-2 seconds. It will take the radio about 1 minute to completely power back on to be ready to play.

In Deep Sleep mode all functions are disabled including the alarm, remote, Wi-Fi, Ethernet, and Bluetooth connections. This reduces power consumption and is especially helpful when utilizing the Optional battery (sold separately). Since all operations are turned off you will not be able to see the radio on your network or turn it back on with the infrared remote control. For typical daily use Deep Sleep mode is not suggested or needed.

Presets, settings, and passwords are saved even in deep sleep mode, and during power outages.

Master Power Off

In order to completely turn your radio off, without having to remove your battery or unplug the power cable please select **Master Power Off**. This will completely turn the radio off. All your settings, password, presets will remain saved in this mode. To delete all settings refer to **Factory Reset** on page 27.

Network Info

Network Info displays the details of the current network configuration of the Mondo+. The MAC address of the Mondo+ can be found in the network info.

1. Press the **Home Button** and turn the **Tune Knob** to highlight Radio Settings. Press the **Tune Knob** to select.
2. Turn the **Tune Knob** and highlight Network Info and press the **Tune Knob** to select.
3. The current network configuration will be displayed. Turn the **Tune Knob** to scroll through the configuration details.

Firmware Update

Grace Digital may occasionally update the software for the Mondo+ and it is recommended that you always update the software when new software becomes available. The Mondo+ will automatically check for software updates when you turn it on, but you also can manually check for any available software updates.

1. Press the **Home Button** and turn the **Tune Knob** to highlight Setup. Press the **Tune Knob** to select.
2. Turn the **Tune Knob** to highlight Firmware Update and press the **Tune Knob** to select.
3. If the Mondo+ has already detected that a software update is available, it will show a software update available.

If not, the Mondo+ will check for a software update. If no update is available, the Mondo+ will display "No new updates".

4. If a software update is available, turn the **Tune Knob** to highlight Install update and press the **Tune Knob** to select.
5. The software update will be applied to the Mondo+. **Do not turn the Mondo+ off during the update, or disconnect the Mondo+ power.** When complete, the Mondo+ will restart to complete the update, and display "Please press the POWER button".

Radio Info/Change Radio Name

The Info option displays information about the Mondo+ serial number and software version.

1. Press the **Home Button** and turn the **Tune Knob** to highlight Radio Settings. Press the **Tune Knob** to select.
2. Turn the **Tune Knob** to highlight Info and press the **Tune Knob** to select. The information will be displayed.

You can change the name of your radio by selecting Radio Info then highlight and select Device Name. The new name will now show up in Chromecast enabled apps, used for the Google assistant, and broadcast via Bluetooth.

Factory Reset

The Factory Reset option restores the Mondo+ to the factory settings. It will erase all the stored network settings, SiriusXM streaming username and password, presets, alarm clock settings, and set all other options back to the factory settings.

1. Press the **Home Button** and turn the **Tune Knob** to highlight Radio Settings. Press the **Tune Knob** to select.
2. Turn the Tune Knob to highlight Factory reset and press the Tune Knob to select.
3. Confirm that you really want to proceed with the factory reset. Confirm factory reset will be highlighted. Press the **Tune Knob** to proceed with the factory reset, or press the **BACK Button** to abort the factory reset.
4. The screen will display “Restoring factory defaults”, restart the Mondo+ when complete and display “Please press the POWER button”.

NOTE: You will have to connect the Mondo+ to a network (see “Connect to a Wireless Network”).

Display Settings

There are three different brightness backlight settings, and each type of backlighting can be set to a brightness from 0 to 19.

Active: This setting controls the brightness of the display screen when the Mondo+ is On, and you are interacting with the Mondo+ by pressing buttons, etc. After 30 seconds of inactivity, the display changes to the inactive setting.

Inactive: This setting controls the brightness of the display screen when the Mondo+ is On, but you have not interacted with the Mondo+ by pressing buttons, etc., for 30 seconds. You might use this setting to set the brightness when in a darkened room as you are falling asleep while listening to the Mondo+.

Standby: This setting controls the brightness of the display screen when the Mondo+ is in Standby Mode.

To set the Display Brightness:

1. Press the **Home Button** and turn the **Tune Knob** to highlight Radio Settings. Press the **Tune Knob** to select.
2. Turn the **Tune Knob** to highlight Display Settings and press the **Tune Knob** to select.
3. Turn the **Tune Knob** to highlight Display Brightness and press the **Tune Knob** to select.
4. Turn the **Tune Knob** and highlight Active, Inactive, or Standby and press the **Tune Knob** to select.
5. Turn the **Tune Knob** to the desired setting, 0 to 19 and press the **Tune Knob** to select your setting.

Optionally - When the radio is in Standby Mode, you can rotate the **Tune Knob** to temporarily change the standby backlight brightness. This is perfect to make the display 100% dark while sleeping, or brighter to see the clock.

To set the Default Inactive Screen:

You can select either the Now Playing screen or large Time and Date Screen to be displayed when the music is playing.

1. Press the **Home Button** and turn the **Tune Knob** to highlight Radio Settings. Press the **Tune Knob** to select.
2. Turn the **Tune Knob** to highlight Display Settings and press the **Tune Knob** to select.
3. Turn the **Tune Knob** to highlight Default Inactive Screen and press the **Tune Knob** to select.
4. Turn the **Tune Knob** to highlight either Now Playing Screen or Large Time and Date Screen. Press the **Tune Knob** to select.

Inactive Display Time delay:

Allows the ability to change the duration of time that the radio will take to go from your active backlight setting to the inactive setting.

1. Press the **Home Button** and turn the **Tune Knob** to highlight Radio Settings. Press the **Tune Knob** to select.
2. Turn the **Tune Knob** to highlight Display Settings and press the **Tune Knob** to select.
3. Turn the **Tune Knob** to highlight Inactive Display Time Delay and press the **Tune Knob** to select.
4. Turn the **Tune Knob** to highlight Playback or No playback and press the **Tune Knob** to select.
5. Turn the **Tune Knob** to adjust the chosen time delay and press the **Tune Knob** to select.

Your Mondo+ has been designed and built to be trouble-free but if you experience a problem, here's some troubleshooting hints.

If you see this on the screen:	Try this:
Initializing Network Connecting to <wireless network> Error loading menu	<ul style="list-style-type: none"> • The Mondo+ is attempting to connect to your network. If this message is displayed more than one minute, make sure your network is connected to the Internet. To verify that you have an Internet connection, refer to "Software Update" on page 37 and follow the procedure. If you receive the message No Update Available, or New version available, then the Radio is connected to the Internet. If you get the message, Login failed, then you don't have an Internet connection. Check with your network administrator for Internet connectivity on your network. • Turn the Mondo+ Off and On again.
Buffering	<ul style="list-style-type: none"> • The Mondo+ is loading the channel information. If this message is displayed for more than one minute, make sure your connection to the Internet has not been interrupted. See Connecting (previous troubleshooting item) and verify your Internet connection. • Turn the Mondo+ Off and On again.
Updating	<ul style="list-style-type: none"> • Your Mondo+ is installing a software update. Do not turn the Mondo+ off or disconnect the power. Allow the software update to complete.
Not Connected to the Internet Retrying	<ul style="list-style-type: none"> • The wireless network information you entered is incorrect. Verify and re-enter the information. • You have entered an incorrect password for a secure wireless network. Verify and re-enter the information. • If you have manually configured a network connection, you have entered one or more incorrect settings. Verify and re-enter the information.

If this happens:	Try this:
You do not receive the same Sirius or XM channels you receive on your Satellite Radio	<ul style="list-style-type: none"> • SiriusXM streaming does not have all of the same channels as the Sirius or XM satellite service. Check siriusxm.com/channellineup for the latest SiriusXM streaming channel lineup.
The Scan for Network feature fails before the Mondo+ connects to your network	<ul style="list-style-type: none"> • Your network has DHCP disabled. You'll have to manually configure your network connection. Refer to "Manually Connecting to a Wireless Network" on page 10.
The Scan for Network feature does not find your wireless network	<ul style="list-style-type: none"> • Your wireless network has a hidden name (SSID). If so, you will have to manually configure your wireless network connection. Refer to "Manually Connecting to a Wireless Network" on page 10. • The wireless signal from your access point is too low. Try moving the Mondo+ closer to your access point and see if the Scan for Network feature finds your wireless network.

Appendix

Listening to SiriusXM

Now Playing Screen

The Now Playing screen provides details about the currently playing song, show, or game.



Viewing and tuning Channels By Category

Channels are organized into categories to make it easier for you to find the ones that suit your taste.

1. While in the SiriusXM app.
2. Turn the **Tune Knob** to highlight Categories and press the **Tune Knob** to select.
3. Turn the **Tune Knob** to highlight a category and press the **Tune Knob** to select the category.
4. Turn the **Tune Knob** to scroll through the channels in the category. Press the **Tune Knob** to select a channel.

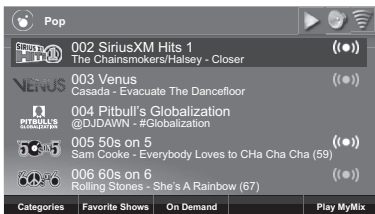
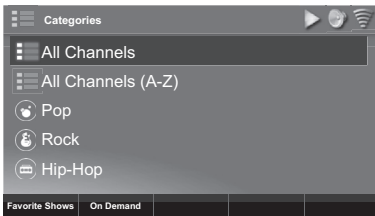

Viewing and Tuning Channels in a List

Channels can be tuned from a list of all available channels, “All Channels”.

1. While in the SiriusXM app.
2. Turn the **Tune Knob** to highlight Categories and press the **Tune Knob** to select.
3. Press the **Tune Knob** to highlight All Channels and press the **Tune Knob**.
4. Turn the **Tune Knob** to browse through the channels, and highlight a channel and press the **Tune Knob** to tune the channel. The Mondo+ will tune to the channel.



TIP! Go to siriusxm.com/channellineup for the latest SiriusXM channel lineup.

Start Now

You can tune to a show that aired in the past 5 hours on a channel by using the **Start Now Button** when at the Now Playing screen.

1. At the Now Playing screen, press the **Start Now Button**.
2. Turn the **Tune Knob** to highlight a show in the list and press the **Tune Knob** to begin playing the show.

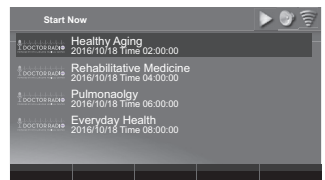
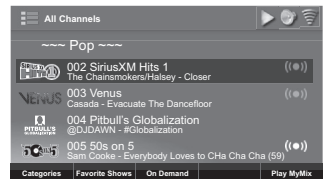
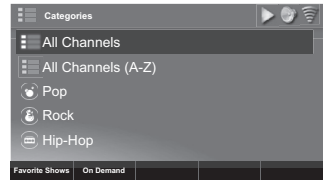

Presets

You can assign up to 10 of your favorite channels to the preset buttons (**P1 - P10**), so you can easily tune them. Presets can be either channels, or channels you have personalized for MyMix.

To assign a favorite channel to a Preset Button:

1. Tune to the channel you want to save as a preset.
2. Press and hold a **Number Button (P1 - P10)** to assign the custom channel as a preset to that button.



IMPORTANT! If the button you choose already has a preset channel assigned to it, the number button will be replaced with the new preset channel.

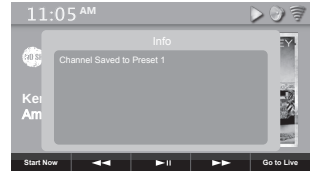

To tune a Preset channel:

1. Press the **Number Button (P1 - P10)** that is assigned to the Preset channel. The Mondo+ will tune to the channel.

MyMix Now Playing Screen

You can personalize your listening preferences for many music and comedy channels, to hear more of the type of music you prefer. Channels which can be personalized have the MyMix icon ((M)) displayed in the channel list.

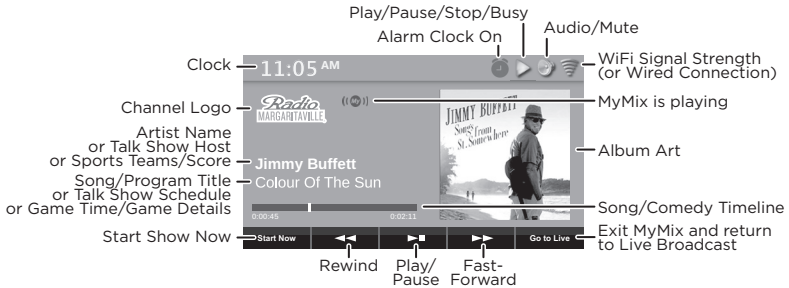

You can personalize your listening experience by adjusting the parameters of a channel's genre. The parameters will vary from channel to channel.

Personalizing a Channel for MyMix

1. Tune to the channel which you want to personalize for MyMix and press the **Now Playing Button**.
2. Press the **Play MyMix Button**.
3. Turn the **Tune Knob** to highlight a personalization setting and press the **Tune Knob** to select the setting. Then turn the **Tune Knob** to adjust the setting. Press the **Tune Knob** again to confirm the setting.
4. If you do not want to hear DJ talk, select the Music Only checkbox by tuning the **Tune Knob** to highlight Music Only and press the **Tune Knob** to select. ("Music Only" will also remove DJ talk on the comedy channels.)
5. When you have finished adjusting the MyMix personalization settings, press the **Play MyMix Button**.
6. MyMix will now play the channel personalized according to your preference. A MyMix icon is displayed directly to the right of the channel logo indicating that you are listening to MyMix. If you wish to exit MyMix, press the **Go to Live Button**.

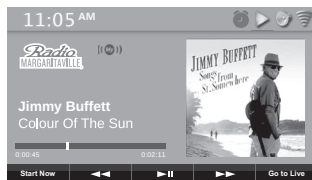
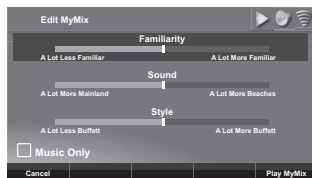

Tuning to a MyMix Channel

Once you have personalized a channel for MyMix, you can tune to the **MyMix channel**.

1. While in SiriusXM app.
2. Turn the **Tune Knob** to highlight Categories and press the **Tune Knob** to select.
3. Press the **Tune Knob** to select All Channels or turn the **Tune Knob** to the category desired and press the **Tune Knob** to select.
4. Turn the **Tune Knob** to browse through the channels. Channels which you have personalized for MyMix will show the MyMix icon (bright). Turn the **Tune Knob** to highlight a channel and press the **Play MyMix Button**.
5. If you are already tuned to a channel which has been personalized for MyMix, you can tune to the MyMix channel by pressing the **Now Playing Button** and then pressing the **Play MyMix Button**.
6. The MyMix channel will be tuned and the MyMix icon displayed directly to the right of the channel logo to indicate the MyMix channel is playing.

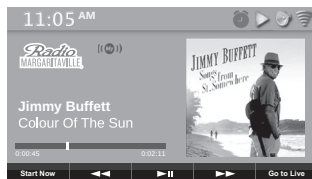
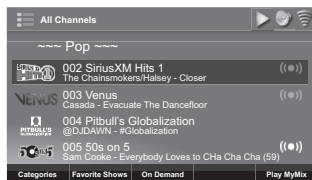

As songs play from the MyMix channel, a timebar is displayed. You can press the **Pause/Play Button** to pause, and **Rewind** and **Fast Forward Buttons** rewind or advance.

Ending MyMix

When the a MyMix channel is playing, you can end MyMix and return to live SiriusXM without changing the channel.

1. When listening to a MyMix channel, press the **Go to Live Button**. The channel will be tuned live, and the MyMix icon will no longer be displayed on the Now Playing screen.

Editing a MyMix Channel

You can change the personalization settings of a MyMix channel that had previously been personalized for MyMix.

1. Tune to the MyMix channel, or tune to the channel which has been personalized for MyMix.
2. Press the **Now Playing Button** and press the **Edit MyMix Button**.
3. Adjust the MyMix personalization settings and then press the **Play MyMix Button** to save the settings and play the MyMix channel.

On Demand Now Playing Screen

On Demand allows you to listen to shows which have aired previously on SiriusXM or are currently playing.



Listening to On Demand Shows

On Demand shows can be found by several search methods.

1. While in the SiriusXM app.
2. Either turn the **Tune Knob** to highlight On Demand and press the **Tune Knob**, or turn the **Tune Knob** to highlight Categories and press the **On Demand Button**.
3. Next select the method by which to search for shows. Turn the **Tune Knob** to highlight a search selection and press the **Tune Knob** to select.
 - All Shows: These are all available shows listed by channel number.
 - Favorites: These are shows which you have saved as favorite shows.
 - Shows by Category (Pop, Rock, Etc.): These are all shows in a category, listed by channel number.
4. Once you have searched for and located a show, you can select a show episode from the show list. Turn the **Tune Knob** to highlight a show in the list and press the **Tune Knob**.
5. If you have selected a show from the list which has more than one episode, select an episode by turning the **Tune Knob** to highlight a show episode. Press the **Tune Knob** to listen to the show episode, or press the **BACK Button** to return to the show list.
6. The circles show at the right of each show denote whether the show episode has been listened to or not. Empty circles show the show episode has not been listened to, a half filled circle denotes the show episode has been partially listened to, while a filled circle denotes the show episode has been listened to in its entirety.

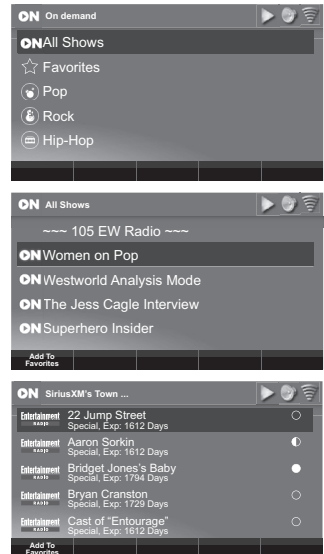

Adding an On Demand Show to Favorites

You can add an On Demand show to Favorites to make the show episodes easy to find and tune.

1. Search for and locate a show. (Refer to "Listening to On Demand Shows" on page 36.)
2. Once you have located a show, or a show episode, highlight the show or show episode by turning the **Tune Knob**.
3. Press the Add To Favorites Button to add the show to Favorites.
4. The confirmation message Show added to favorites will be displayed to confirm the show has added to favorites.

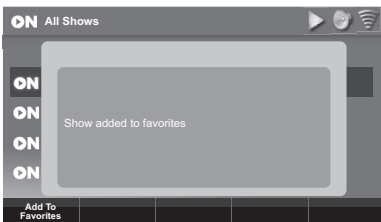

The Mondo+ keeps a list of the most recent shows and channels you have listened to. You can easily tune to them again from the Recent list.

1. While in the SiriusXM app.
2. Turn turn the **Tune Knob** to highlight **Recent**, and press the **Tune Knob** to select.
3. Turn the **Tune Knob** to highlight a recent show or channel in the list and press the **Tune Knob** to tune the show or channel.
4. If a channel in the Recent list has been personalized for MyMix, the MyMix channel can be tuned by pressing the **Play MyMix Button**.

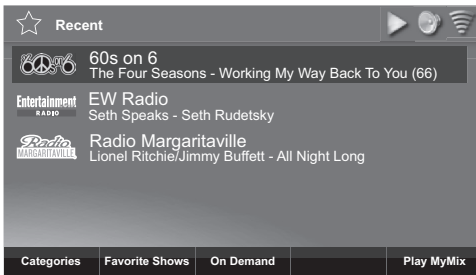

You can add shows to Favorites using On Demand (page 36), and then select and listen to them from Favorites.

Listening to a Favorite Show

1. While in the SiriusXM app.
2. Turn the **Tune Knob** to highlight **On Demand**, and press the **Tune Knob** to select.
3. Turn the **Tune Knob** to highlight **Favorites**, and press the **Tune Knob** to select.
4. Turn the **Tune Knob** to highlight a favorite show in the list and press the **Tune Knob** to listen.

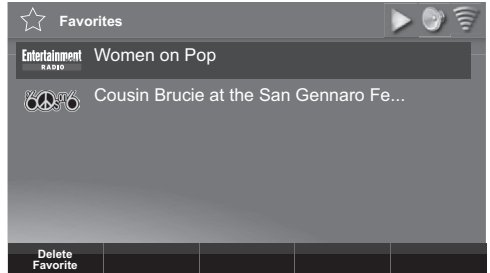

Deleting a Favorite Show

1. While in the SiriusXM app.
2. Turn the **Tune Knob** to highlight **On Demand**, and press the **Tune Knob** to select.
3. Turn the **Tune Knob** to highlight **Favorites**, and press the **Tune Knob** to select.
4. Turn the **Tune Knob** to highlight the favorite show in the list which you want to delete and press the **Delete Favorite Button**.
5. The message **Show removed from favorites** is displayed to confirm that the show has been deleted from favorites.

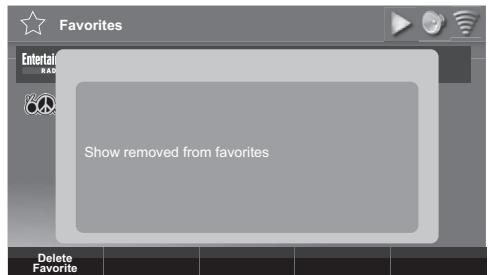

Start Now, Pause/Play, Rewind, Fast Forward, and Go to Live

The Mondo+ is able to pause, rewind, and fast-forward through channels and content. When listening to SiriusXM channels live, you can rewind up to the past 5 hours of content that aired on the channel. When listening to On Demand content, or content saved as Favorites you can also pause, rewind, and fast-forward through the show episode. When listening to a MyMix channel, you can pause or resume playing the current song, fast-forward to the next song, or rewind to the previous song.

The Now Playing screen has Context Sensitive Buttons at the bottom of the display screen for these features:

Start Now: (Available when listening to SiriusXM channels live.) Pressing Start Now lists all the shows that have played on the channel in the past 5 hours. Select a show to begin listening from the beginning.

Play/Pause: Pause and resume playing the channel or content.

Rewind: (Available when listening to SiriusXM, On Demand, and MyMix.) Rewinds back through content. When listening to SiriusXM live, you can rewind 5 hours. When listening to On Demand or Favorite content, you can rewind back through the show episode to the beginning. When listening to MyMix, you can rewind back to the previous song.

Fast-Forward: (Available when listening to SiriusXM, On Demand, and MyMix.) Fast forward through the channel or content. When listening to SiriusXM in Replay mode, you can fast forward until you reach live. When listening to On Demand or Favorite content, you can fast forward through the show until you reach the end. When listening to MyMix, you can Fast Forward to the next song.

Go to Live: (Available when listening to SiriusXM channels live, or MyMix.) If you are listening to SiriusXM, and are not listening live, pressing Go to Live will jump to live. If you are listening to MyMix, pressing Go to Live will exit MyMix and play the channel live.

TuneStart

TuneStart plays the current song from the beginning when you tune to a music channel. TuneStart is disabled by default, or if you had previously enabled TuneStart for your SiriusXM streaming account, it will be enabled on the Mondo+.



NOTE: Certain music channels are not eligible for TuneStart due to the way in which they are broadcast. While these music channels can be saved as smart favorites, TuneStart will not occur for these channels.

To Enable or Disable TuneStart

1. While in the SiriusXM app press the **Tune Knob** to highlight Setup. Press the **Tune Knob** to select.
2. Turn the **Tune Knob** and highlight **SiriusXM Account** and press the **Tune Knob** to select.
3. Turn the **Tune Knob** and highlight **TuneStart** and press the **Tune Knob** to enable or disable **TuneStart**. A checkmark in the TuneStart box indicates that TuneStart is enabled.

Enter Your SiriusXM Streaming Account Information

The Mondo+ requires your SiriusXM streaming username and password to connect to SiriusXM. If are not yet subscribed to SiriusXM, go to siriusxm.com/streaming or call **866-635-2349**. When subscribed, you will be provided with your account username and password.

1. While in the SiriusXM app turn the **Tune Knob** to highlight Setup and press the **Tune Knob** to select. Turn the **Tune Knob** to highlight **SiriusXM Account** and press **Tune Knob** to select.
2. Username will be highlighted. Press the **Tune Knob**. Enter each character in your SiriusXM streaming username and press the **Tune Knob** to select the character. When complete press the **Enter Button**. Your username is case sensitive.
3. Turn the **Tune Knob** to highlight Password and press the **Tune Knob** to select. Enter each character in your password and press the **Tune Knob** to select the character. When complete press the **Enter Button**. Your password is case sensitive.
4. The Mondo+ will connect to SiriusXM and confirm the username and password you entered. If correct, "SiriusXM credentials accepted" will be briefly displayed.

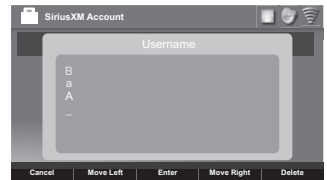

The installation is complete.

Mondo+

Dimensions: 10.75 in (W) X 6.0 in (H) X 5.25 in (D)
273 mm (W) x 152 mm (H) x 133 mm (D)
Weight: 3.0 lbs (1.36 kg)

Power Adapter

Input: 100-240 VAC, 50/60 Hz, 0.2 A
Output: 12 VDC, 1.0 A

Remote Control

Dimensions: 1.5 in (W) x 3.375 in (H) x .25 in (D)
38 mm (W) x 86 mm (H) x 6 mm (D)
Weight: 0.6 oz (20 g)
Battery: AAA

Audio

Headphone: 3.5 mm diameter mini stereo jack
Aux In: 3.5 mm diameter mini stereo jack

Supported Audio Codecs

- MP3
- AAC
- FLAC
- LPCM/WAV/AIFF
- ALAC
- WMA, WMA9
- Ogg Vorbis

Supported Playlist

- ASX
- M3U
- PLS
- WPL

Supported Container Formats

- WAV
- M4A
- OGG
- AIFF

Supported Protocols

- SHOUTcast
- HTTPS
- WMA streaming
- RTSP/SDP

Supported MP3 encoding parameters

- Sampling rates [kHz]: 32, 44.1, 48
- Resolution [bits]: 16
- Bit rate [kbps]: 32, 40, 48, 56, 64, 80, 96, 112, 128, 160, 192, 224, 256, 320, VBR
- Channels: stereo, joined stereo, mono
- MP3PRO playback
- MP3 File extensions: *.mp3
- Decoding of ID3v1, ID3v2, MP3 ID tags including optional album art in .jpeg format up to 2 megapixels
- Gapless MP3: Playback is gapless if the container provides LAME encoder delay and padding tags.

Supported Vorbis encoding parameters

- Sampling rates [kHz]: 32, 44.1, 48
- Resolution [bits]: 16
- Nominal bit rate [kbps] (quality level): 80 (Q1), 96 (Q2), 112 (Q3), 128 (Q4), 160 (Q5), 192 (Q6),
- Channels: stereo
- The audio player supports reading of Vorbis content stored in Ogg containers. Supported file name extensions: *.ogg and *.oga.
- The audio player supports decoding of Vorbis comments.
NOTE: There is no specification for tag names. The system relies on the OSS implementation.
- Tag names decoded: TITLE, ALBUM, ARTIST, GENRE.
- Binary data (e.g. for album art) is not supported.
- The audio player supports gapless Vorbis playback.

Supported FLAC encoding parameters

- Sampling rates [kHz]: 44.1, 48, 88.2, 96, 176.4, 192
- Resolution [bits]: 16, 24
- Channels: stereo, mono
- The audio player supports reading of FLAC content stored in native FLAC containers. Supported file name extensions: *.flac
- FLAC comments and ID tag support:
 - The audio player supports decoding of FLAC comments.
NOTE: There is no specification for tag names. The system relies on the OSS implementation.

- Tag names decoded: TITLE, ALBUM, ARTIST, GENRE.

NOTE: ID3v2 tags for native FLAC and FLAC containers are out of standard but should be supported if placed at the beginning of a file, see the FLAC-FAQ.

- Gapless FLAC

Supported Uncompressed LPCM , WAV, AIFF encoding parameters

- Sampling rates [kHz]: 44.1, 48, 96, 192
- Resolution [bits]: 16, 24
- Channels: stereo, mono
- Gapless LPCM, WAV, and AIFF
- Supported file name extensions: *.wav, *.aiff, *.aif. (AIFF-C not supported)
- The audio player supports extraction of INFO chunks in WAV containers for the following metadata tags: TITLE, ALBUM, ARTIST
- The audio player supports reading of uncompressed LPCM content stored in AIFF containers.
- Support of ID3 chunks in AIFF containers

Supported AAC (AAC-LC /HE-AAC/HE-AAC v2) encoding parameters

- Sampling rates [kHz]: 32, 44.1, 48, 96
- Resolution [bits]: 16
- Bit rate [kbps]: 8, 16, 24, 32, 40, 48, 56, 64, 80, 96, 112, 128, 160, 192
- Channels: stereo, mono
- The audio player supports reading of aac content stored in single stream aac files and mp4 containers. Supported file name extensions: *.aac, *.m4a

NOTE: m4b containers are supported for playback only; bookmarks, chapter markers, hyperlinks, images and other metadata embedded in m4b containers are not supported.

NOTE: Single stream aac files and mp4 containers support ID3 tagging, hence extraction of that metadata is covered by extraction of ID3 tags for mp3 content.

- AAC ID3 tags support
- The audio player supports decoding of ID3v1 and ID3v2 tags in containers
 - The audio player supports decoding of AAC comments.

NOTE: There is no specification for tag names. The system relies on the OSS implementation.
 - Tag names decoded: TITLE, ALBUM, ARTIST, GENRE.
- Gapless AAC: Playback is gapless if the M4A container provides encoder delay and padding information according to iTunes tags, or encoder delay according to Nero tags.

Supported WMA encoding parameters

- Sampling rates [kHz]: 32, 44.1, 48
- Resolution [bits]: 16
- Bit rate [kbps]: 48, 64, 96, 128, 192
- Channels: stereo, mono
- The audio player supports reading of wma content stored in native wma files. Supported file name extensions: *.wma
- The audio player supports extraction of ASF metadata from native wma files.

Supported ALAC encoding parameters

- Sampling rates [kHz]: 44.1, 48, 88.2, 96, 176.4, 192
- Resolution [bits]: 16, 24
- Channels: stereo, mono
- Supported ALAC containers and file extensions
- The audio player supports reading of ALAC content stored in mp4 containers. Supported file name extensions: *.m4a
- ALAC ID3 tags support
- The audio player supports decoding of ALAC comments.
 - NOTE:** There is no specification for tag names. The system relies on the OSS implementation.
- Tag names decoded: TITLE, ALBUM, ARTIST, GENRE.
- Gapless ALAC

NOTE: For correct gapless decoding, the container must provide correct encoder delay metadata (or no encoder delay at all!), which is different from lossy compression formats like AAC.

Environmental Information

Follow local guidelines for waste disposal when discarding packaging, electronic appliances, and batteries.

Your Radio is packaged with cardboard, polyethylene, etc., and does not contain any unnecessary materials.

WARNING! This product contains chemicals known to the State of California to cause cancer and birth defects or other reproductive harm.

The user is cautioned that changes or modifications not expressly approved by Sirius XM Radio Inc can void the user's authority to operate this device.

This device complies with Part 15 of the FCC Rules:

1. This device may not cause harmful interference.
2. This device must accept any interference received, including interference that may cause undesired operation.

NOTE: This equipment has been tested and found to comply with the limits for a Class B digital device, pursuant to Part 15 of the FCC Rules. These limits are designed to provide reasonable protection against harmful interference in a residential installation.

This equipment generates, uses and can radiate Radio frequency energy and, if not installed and used in accordance with the instructions, may cause harmful interference to Radio communications. However, there is no guarantee that interference will not occur in a particular installation. If this equipment does cause harmful interference to Radio or television reception, which can be determined by turning the equipment off and on, the user is encouraged to try to correct the interference by one or more of the following measures:

- To comply with FCC RF exposure compliance requirements, a separation distance of at least 20 cm must be maintained between the antenna of this device and all persons.
- This device must not be co-located or operating in conjunction with any other antenna or transmitter.

End User License Agreement (EULA) Terms and Conditions

(1) End User will have only a non-exclusive, nontransferable license to use the software embedded (Licensed Software) in the GRACE DIGITAL product (Licensed Product), and hence the license is restricted to the scope of the use in the Licensed Product. (2) End User acknowledges that any and all transactions by means of the Licensed Software can only be performed on a certain Cloud Server, which is regulated in the terms and conditions that are laid down in the "Cloud Server terms and conditions" (identified below) which are explicitly accepted by the End User. (3) End User is prohibited from reverse engineering (unless required by law for interoperability), disassembly or decompilation of the Licensed Software and the duplication of the Licensed Software. (4) End User is prohibited from transferring the Licensed Software to another machine. Even if the original Licensed Product is no longer in use, or if the Licensed Software is removed from the original hardware, the EULA is tied to the device on which the Licensed Software is first installed. (5) GRACE DIGITAL disclaims, to the extent permitted by applicable law, any warranty including the implied warranties of satisfactory quality, fitness for a particular purpose, non-infringement and those arising from a course of performance. GRACE DIGITAL does further not warrant that the operation of the Licensed Software will be uninterrupted or error free or that all deficiencies will be corrected. (6) GRACE DIGITAL disclaims any liability for any damages, whether direct, indirect, incidental, or consequential, arising from the use of the Licensed Software. (7) GRACE DIGITAL disclaims liability for the availability and proper functioning of such audio services features, unless it can be demonstrated that GRACE DIGITAL acted willfully or was grossly negligent. (8) The End User acknowledges that the Licensed Software can only be used in conjunction with the Licensed Product and further, that Licensed Software under certain circumstances supports audio services feature, such as Google Cast, which are all subject to the terms of service entered into by the End User and the respective developer, e.g. Google Inc., directly. (9) End User consents that its use of the Licensed Software is audited indirectly by GRACE DIGITAL through the logging of the usage activities of the Cloud Server and that improper use can also be reported to GRACE DIGITAL, and that any audit rights of the Licensor can be assigned to GRACE DIGITAL. (10) The End User is notified that the permission to use the Licensed Software ends with its revocation by GRACE DIGITAL under certain circumstances, which are provided for in "Revocation of the right to use the Licensed Software" (identified below). (11) The End User must acknowledge that the developers of the audio services features, such as Google Inc., may also revoke the license keys to use their feature independently from the EULA and therefore, GRACE DIGITAL cannot intervene in such measures on its own or influence such actions in any other way and cannot be made responsible for the interruption of the services of audio services features, such as Google Cast by the End User. (12) GRACE DIGITAL is designated and accepted expressly as a third party beneficiary due to its intellectual property rights in the Licensed Software of all of the terms of the EULA and End User shall agree that GRACE DIGITAL shall be entitled to enforce its intellectual property rights in the Licensed Software as such under this EULA.

Cloud Server terms and conditions

- (i) The End User acknowledges that the Licensed Software was developed by StreamUnlimited Engineering GmbH (hereinafter referred to as "**SUE**"), and that SUE organizes and supports the cloud server, which is required to access the audio services (the "**Cloud Server**").
- (ii) The End User acknowledges that any use of the Licensed Software and any supported online music feature (e.g. Google Cast) or any other feature may involve a transaction to a Cloud Server, which could be the "Google App Engine", operated and hosted by Google, Inc., USA, or any similar operated and hosted by a third party, and therefore SUE is not liable for any unauthorized access to this Cloud Server, and the data processed hereunder.
- (iii) End User may only access the Cloud Server via subscription with the Licensed Product or in a manner otherwise approved by Grace Digital Inc.
- (iv) Upon acceptance of the terms and conditions of the EULA the End User will be granted a non-exclusive, revocable, non-transferable, limited license to use the respective Cloud Server solely for the purpose of streaming content by means of the Licensed Software and the respective online music feature as embedded in the Licensed Product in accordance with the terms and conditions of the EULA.
- (v) End User acknowledges and agrees that it does not have, nor will it claim any right, title or interest in the Cloud Server, data, applications, methods of doing business or any elements thereof, or any content processed on the Cloud Server.
- (vi) The license of the End User to use the Cloud Server terminates with the abandonment of the ownership in the Licensed Product.

Data Processing for activation and auditing purpose

- (vii) End User acknowledges that SUE is entitled to audit the proper use of the Licensed Software by the End User, in order to detect any illegal or otherwise irregular use of the Licensed Software (e.g. transfer of a copy of the Licensed Software to a non-licensed device), with appropriate means.
- (viii) The Licensed Product may communicate with the Cloud Server during any operation, which generates certain data that are used to authenticate and to audit the legitimate use of the Licensed Software by SUE. This data processing is a feature, which does not infringe the interests of the End User in secrecy deserving protection, because SUE can invoke on its legitimate prevailing interests as owner of the intellectual property rights in the Licensed Software to audit the proper use.
- (ix) Hence, End User acknowledges that the usage of the Licensed Software is monitored by SUE in a way that any operation by using the Licensed Product is logged by SUE by means of processing the product MAC addresses, the IP Address of the End User, the brand name, model name and firmware version of the Licensed Product, the Token (if applicable) and a timestamp regarding the transactions upon each access to the Cloud Server. By analyzing these data SUE can detect any misuse of the Licensed Software. The End User further acknowledges that SUE may store and process any data from such monitoring activities, analyze this data in the case of a strong suspicion of unlawful misuse of Licensed Software and also transmit the data in a non-personal related format to the respective developers of any supported features, provided that the suspicion of infringement by the End User is substantiated.

I) Revocation of the right to use the Licensed Software

- (x) The End User acknowledges that the right to use the Licensed Software can be revoked by SUE, if the analysis of the monitored data indicates a strong suspicion of unlawful misuse of the Licensed Software, and that he receives an automated notification with the instruction to contact Grace Digital customer support. If the End User turns out to be the legitimate one, the customer support can enable again the Licensed Product for the End User.
- (xi) The End User accepts that SUE is third party beneficiary of the EULA due to its intellectual property rights in the Licensed Software with regard to the use of the Licensed Software and can, therefore, defend the rights in the Licensed Software as well as enforce any rights and claims from a misuse of the Licensed Software or an infringement of the EULA directly against the End User.

Grace Radio Station List

End User acknowledges that when using the Grace radio station list that the Grace servers identifies the user's radio by means of processing the product MAC addresses, and a timestamp regarding the transactions in order to provide the radio the list of stations list. The End User acknowledges that Grace Digital may store and process any data from such communications activities in order to provide service to the user's radios.

The Grace Radio stations list is maintained by Grace and some independent partners. We do not warrant or guarantee the access to a specific radio station for the life of the product as Grace Digital cannot control the radio station's desire to be in the database or for a station's ability to continue operations.

Other Third Party Service Providers

End User acknowledges that when using other 3rd party service providers on the Grace radios that those individual service providers may track the radio's interaction with their 3rd party service. The End User acknowledges that Grace Digital does not manage, control or track usage of the radios when the end user is using 3rd party service providers. Additionally, while Grace Digital will do their best to ensure that each service is available on the Grace radio for the life of the product, Grace Digital cannot control nor is it connected to any service provider. Grace Digital cannot guarantee that service providers will continue to operate, or continue to make their service available on this device under the current terms offered by the various 3rd party service providers.

Important Notice: Required Subscription

Hardware and subscription sold separately, and activation fee required. Other fees and taxes may apply.

Subscriptions governed by SiriusXM Customer Agreement; see www.siriusxm.com. Service automatically renews into the subscription Package you choose (which may differ from the Package which arrived with the Radio), for additional periods of the same length, and automatically bills at then-current rates, after any complimentary trial or promotional period ends. You must call us to cancel at 1-866-635-2349. Fees and programming are subject to change.

© 2017 Grace Digital Inc. "Sirius", "XM" and all related marks and logos are trademarks of Sirius XM Radio Inc. and its subsidiaries. All other marks and logos are the property of their respective owners. All rights reserved. Certain features depend on subscription package.

Limited Manufacturer's Warranty

- Your Internet radio is supported by a limited manufacturer's warranty for product defects in material or workmanship that may be evident under normal use for 1 year from date of purchase from an authorized franchisee or dealer.
- The warranty stated herein is the only warranty applicable to this product. All other warranties, expressed or implied are hereby disclaimed and are limited by the written limited warranties contained herein. Except as provided herein, the manufacturer shall have no liability or responsibility to a customer or any other person or entity with respect to any liability, loss or damage caused directly or indirectly by use or performance of the product or arising out of any breach of this warranty, including, but not limited to, any damages resulting in inconvenience, loss of time, data, property, or profit or any indirect, special, incidental, or consequential damages, even if the manufacturer has been advised of the possibility of such damages.
- In the event of a product defect during the warranty period, return of the product and your sales receipt as proof of purchase date for your unit is required and shall, at the discretions of the manufacturer, result in: (a) correction of the defect by repair without charge for parts and labor; (b) replacement with the same or similar design; or (c) refund for the purchase price if purchased directly and returned within 30 days of purchase. All replaced parts / products, on which a refund may be made, become the property of the manufacturer. New or reconditioned parts / products should be warranted for the remainder of the original warranty period.
- The warranty does not cover: (a) damage or failure caused by or attributed to acts of God, abuse, accident, misuse, improper installation or improper maintenance, alteration, lightning or excessive voltage or current; (b) any repairs other than those provided by Grace Digital; (c) consumables such as fuses or batteries; (d) cosmetic damage; (e) transportation, shipping or insurance costs; (f) costs of product removal, installation, set-up, service adjustment or re-installation.
- Customers are responsible for any shipping costs related to product return, Grace Digital will pay for shipping of the refurbished or replacement radio to the customer to the contiguous United States. All other shipping charges are the customer's responsibility.

**Grace Digital Inc.
11895 Community Road
Poway, CA 92064**

gracedigital.com

support.gracedigital.com | 1.866.446.0961 | support@gracedigital.com